



SPESIALDEKK OG FELG 2021

www.norgesdekk.no





Norgesdekk er importør og grossist av dekk og felger. Med kjente merkevarer innenfor de forskjellige prissegmenter, inntar vi rollen som en av landets ledende aktører innen både dekk og felg.

Vi ønsker å se at våre medarbeidere har optimal produktkunnskap, samtidig som vi er svært opptatt av å kunne levere raskt og effektivt til våre kunder. Dette betyr at våre samarbeidspartnere slipper å ligge med store lager, og dermed kan få rask leveranse fra et av våre lager i Norge.

NORGESDEKK NARVIK

Avdeling Narvik er vår nyeste og vår lengst nord. Den åpnet 13 august 2018 og er Norgesdekk sin 7. avdeling. Med sine 2650m² så blir det vårt største lager i forhold til kundemasse og folketall den er tenkt å betjene. Lageret ligger et steinkast fra Narvik sentrum og nær den nye brua og vil da være strategisk plassert i forhold til distribusjon av varer nordover.



NORGESDEKK AS, avd Bergen
Nordre Toppe 6
5878 Bergen
Tlf. 55 39 16 50
bergen@norgesdekk.no

NORGESDEKK AS, avd Kristiansand
Stemmane 6
4636 Kristiansand
Tlf. 38 53 12 40 | 38 10 71 71
kristiansand@norgesdekk.no

NORGESDEKK AS, avd Oslo
Landskaugveien 54
1914 Ytre Enebakk
Tlf. 22 07 28 30 | 64 83 14 00
oslo@norgesdekk.no

NORGESDEKK AS, avd Narvik
Ornesveien 5
8517 Narvik
Tlf. 76 95 53 00
narvik@norgesdekk.no

NORGESDEKK AS, avd Jæren
Jærvn. 338
4322 Sandnes
Tlf. 51 78 68 60
post@norgesdekk.no

NORGESDEKK AS, avd Tønsberg
Andebu. 80
3170 Sem
Tlf. 33 31 33 33
tonsberg@norgesdekk.no

NORGESDEKK AS, avd Trondheim
Øybergveien 133
7224 Melhus
Tlf. 72 87 11 00
trondheim@norgesdekk.no

SALGS, GARANTI- OG RETURBETINGELSER

Vi forbeholder oss retten til å endre priser uten foregående varsel. Alle ordrer vil bli fakturert med gjeldende pris på leveringsdato. Vi tar forbehold om feiltrykk i denne produktliste. Ved for sen betaling beregnes morarenter etter den til enhver tid gjeldende sats. Norgesdekk (ND) har eiendomsrett til alle varer levert av ND frem til fullstendig betaling (inkl. evt. renter) er betalt.

Ordrer under 3000,- netto, belastes med gebyr, kr. 125,-.

Hvis kunde mottar varer med skader påvirket av ytre omstendigheter/transport, feil antall eller mangler, plikter han å anføre dette på fraktbrev og få transportørens signatur, for så å straks og senest innen 7 dager melde dette til ND. Uten dette kan ikke ND rette opp i slike tilfeller.

Returbetingelser

Det er ikke returret på noen varer med mindre dette er avtalt med ND. Retur av standard varer belastes med et gebyr på 10% returgebyr i tillegg til faktisk frakt. Spesialbestilte (ikke lagerstandard) varer tas ikke i retur. Varer som har vært montert, brukt, ikke er i original emballasje eller er utgått tas ikke i retur. Det samme gjelder varer på spesielle kampanjer eller sell off. Varer som er kjøpt for mer enn 12 mnd. siden, tas ikke i retur. Alle varer som blir returnert i henhold til avtale skal ha kopi av faktura fra ND med, sammen med referanse på hvilken person i ND som har godkjent retur. ND betaler ikke returfrakt.

Garantibestemmelser

ND gir 2 års reklamasjonsrett for fabrikasjonsfeil på alle felger og dekk, regnet fra salgsdato. Eventuelle

reklamasjoner meldes til din selger i ND, på ND sitt reklamasjonsskjema. Dette skal gjøres straks problem er oppdaget. Uten at reklamasjonsskjema er korrekt utfyllt og innsendt, sammen med kjøpskvittering/faktura vil ikke reklamasjonsbehandling skje. Bilder av dekk eller felg skal vise skade/problem. Og på dekk, produksjons uke og år, samt produksjonsnummer. På felg skal også baksida av felg gjøres ren slik at info som står på felgens innsida kan leses på bilde. Fraktkostnader ved en evt. innsendelse av produkt som ikke blir godkjent som garantisak, må dekkes fullt ut av kunde. Ingen produkter skal sendes inn til ND uten avtale om det, kun bilder og reklamasjonsskjema i første omgang.

Intern Transport

Smådekk - Trillebår og traller - små massivdekk..... Side 4-5

Turf - Gressdekk

Rib dekk - Høyvendere etc..... Side 6
 Glattbane - Forhøster etc..... Side 7

Plen og hagedekk

Plenklippere og små hagemaskiner..... Side 8-9
 Større hagemaskiner..... Side 10-11
 Golfbanebiler..... Side 12

Go-cart

Dekk..... Side 12

Snøfresere og Prepareringsmaskiner

Dekk..... Side 13

Tilhengere og Campingvogner

Dekk..... Side 14-16
 Alufelger..... Side 17

Små Traktordekk

Diagonal Drivdekk 4" - 18"..... Side 18-20
 Diagonal Frontdekk 3-Rib 4" - 15"..... Side 21

ATV dekk og felger

OBOR..... Side 22-27
 Wanda..... Side 28-33
 Maxxis..... 34-35
 Duro..... 36-37
 ATV Felger inkludert fitment guide..... Side 38-43

Felger - Nav - Gafler

Felger Ifor Williams..... Side 44
 Felger med nav..... Side 46-47
 Felger med Boring..... Side 48
 Nav for gaffelmontering - Nav med akseltapp..... Side 49
 Gafler..... Side 50

Slanger og Felgbånd

Felgbånd..... Side 51
 Slanger Smådekk..... Side 52
 Slanger ATV og Plendekk..... Side 53
 Slanger Tilhenger - Biler - Campingvogner..... Side 54
 Slanger Motorsykkel etc..... Side 55
 Slanger Landbruk..... Side 56-59
 Slanger Truck - Industri..... Side 60-61

Teknisk Informasjon

Tabeller omregning - Li/Si - Luftrykk..... Side 62-63



INTERN TRANSPORT - INDUSTRI

SMÅDEKK - TRILLEBÅR OG TRALLER



	Dimensjon	Pr (Li/Si)	Dekkmønster	TL/TT	mm	mm	kg	km/t	bar	Følg
3"										
DU2310	2.50-3	4	Duro HF-207 ST11	TT	210	65	100	10	3.9	1.75"
DU2601	2.50-3	4	Duro HF-207 Grå ST11	TT	210	65	100	10	3.9	1.75"
3.8"										
WDP19120050	200x50	4	Wanda P191 ST11	TT	194	48	75	16	1.8	1.25"
DU2305	200x50	2	Duro HF-207A ST11	TT	200	50	75	10	2.5	1.25"
DU2600	200x50	2	Duro HF-207A Grå ST11	TT	200	50	75	10	2.5	1.25"
4"										
DUB1006	2.50-4	2	Duro HF-207 ST11	TT	205	55	135	16	2.5	2.1"
VLC1003A1	2.50-4	4	Veloce Sett ST14 (DIN7777)	TT	205	55	135	16	2.5	2.1"
WDP6075TR8734	3.00-4	4	Wanda P6075 Sett (TR87)	TT	256	83	109	16	3.8	2.1"
DU2332	3.00-4	4	Duro HF-210 ST28	TT	255	84	185	10	3.3	2.1"
DU2603	3.00-4	4	Duro HF-207 Grå ST11	TT	255	78	110	10	3.4	2.1"
TB1152000	3.00-4	6	Trelleborg T-991	TT	260	85	175	10	5	2.1"
TB1152200	4.00-4	6	Trelleborg T-991	TT	312	113	200	10	4.2	2.5"
WDS6075TR1344	4.00-4	4	Wanda P6075 Sett (TR13)	TT	323	107	168	16	3.5	2.5"
DU2341	4.00-4	4	Duro HF-230	TT	295	100	280	10	4.8	2.5"
DU2342	4.00-4	4	Duro HF-210	TT	295	100	280	10	4.8	2.5"
WD130880	4.10/3.50-4	4	Wanda P606 ST17	TL	265	103	160	16	3.5	2.1"
DU2344	4.10/3.50-4	4	Duro HF-201	TT	265	103	160	16	3.5	2.1"
5"										
WD6064105	4.10/3.50-5	4	Wanda P606 ST17	TL	292	86	180	16	3.5	2.75"
6"										
DUB1106	2.00-6	2	Duro HF-207 ST11	TT	256	52	85	10	2.1	1.75"
DU2607	2.00-6	2	Duro HF-207 Grå ST11	TT	260	50	85	10	3.8	1.75"
S2133997	2.50-6	4	Sett ST19 (TR13)	TT	278	66	150	10	4.9	1.75"
DU2350	3.50-6	4	Duro HF-207 ST11	TT	322	80	280	10	4.8	2.10"
WD301464	4.00-6	4	Wanda P301A	TL	348	106	213	16	1.72	2.5"
DU2360	4.00-6	4	Duro HF-207	TT	345	100	310	10	3.5	2.5"
TB1152400	4.00-6	6	Trelleborg T-991	TT	358	107	250	10	4.2	2.5"
DU2366	4.10/3.50-6	4	Duro HF-201 ST28	TT	315	91	200	16	3.5	2.5"
DU1165B	4.10/3.50-6	4	Duro HF-201 ST28 Grå	TT	315	91	200	16	3.5	2.5"

Kun utvalgte mønster er tatt med i liste. Sjekk nettbutikk for fullt sortiment. <https://b2b.norgesdekk.no>

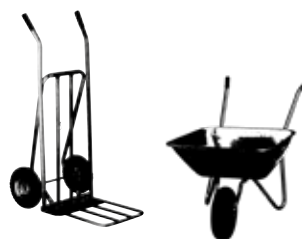

ST11
Wanda P301
Duro HF-207

ST14
Wanda P522

ST15
Wanda P523
Trelleborg T-991

ST16

ST17
Wanda P606

ST19
Duro HF-230

ST28
Wanda P6075
Duro HF-210

ST29

INTERN TRANSPORT - INDUSTRI

SMÅDEKK - TRILLEBÅR OG TRALLER

PART #	Dimensjon	Pr (Li/Si)	Dekkmønster	TL/TT	mm	mm	kg	km/t	bar	Felg
DU2608	12 1/2-2 1/4	2	Dekk Grå	TT	315	58	50	10	2.4	
DUB1124	12 1/2-2 1/4	2	Dekk HF-180 Sort	TT	315	58	50	10	2.4	
8"										
DU2391	3.50-8	4	Duro HF-207	TT	370	82	240	10	2.4	2.5"
DU2370	4.80/4.00-8	4	Duro HF-207	TT	395	98	380	10	2.4	2.5"
DU2371	4.80/4.00-8	4	Duro HF-202	TT	410	105	500	10	4.8	2.5"
DUB1069	4.80/4.00-8	6	Duro HF-202	TT	410	110	600	10	7	2.5"
TB1152600	4.00-8	4	Trelleborg T-991	TT	416	113	230	10	2.6	2.5"
TB1155800	4.00-8	8	Trelleborg T-523	TT	418	123	670	10	8.7	2.5"
WD30148	4.80/4.00-8	4	Wanda P301	TL	409	122	200	16	2.1	2.5"
DU2372	5.00-8	6	Duro HF-223	TT	460	138	600	10	6.8	3.75"
TB1160000	5.00-8	10	Trelleborg T-991	TT	464	143	520	10	5.8	3.75"
9"										
DU2378	6.00-9	6	Duro HF-223	TT	545	165	500	10	3	4"
TB1152900	6.00-9	10	Trelleborg T-991	TT	540	180	670	10	5	4"
10"										
DU2374	4.00-10	4	Duro HF-203	TT	468	112	250	10	2.5	2.5"
13"										
TB1467600	23x5.00-13	10	Trelleborg T-94	TL	635	173	1500	10	8.3	

Kun utvalgte mønster er tatt med i liste. Sjekk nettbutikk for fullt sortiment. <https://b2b.norgesdekk.no>

MASSIVDEKK

PART #	Dimensjon	Pr (Li/Si)	Dekkmønster	TL/TT	mm	mm	kg	km/t	bar	Felg
3"										
BX1702	2.50-3		Brix Massiv Rill							
4"										
BX1705	3.00-4		Brix Massiv Rill							
BX1708	4.00-4		Brix Massiv Rill							
8"										
BX1710	4.00-8		Brix Massiv Rill							
SPS2862	GK4.00-8		Kompletthjul massiv Rill							
SPS2864	EK4.00-8		Kompletthjul massiv Rill							



Brix
Massiv Rill

TURF - GRESSDEKK

RIB DEKK - HØYVENDERE ETC

PART #	Dimensjon	Pr (Li/Si)	Dekkmønster	TL/TT	mm	mm	kg	km/t	bar	Felg
3"										
TB2010	2.50-3	4	Trelleborg T-510	TT	216	74	125	10	7	1.75"
4"										
DU2346	9x3.50-4	4	Duro HF-217	TT	210	95	102	30	3.1	2.75"
DUB1403	11x4.00-4	4	Duro HF-217	TT	270	104	170	10	3.2	2.5"
DU11704	11x7.00-4	60A4	Duro HF-217	TT	270	185	255	20	3,1	6"
6"										
TB1253300	4.00-6	4	Trelleborg T-510 Sett m slange	TT	345	100	250	10	3.4	2.5"
TB1147500	LP140-6	6	Trelleborg T-510	TT	325	134	845	10	7	4.5"
TB1147400	LP140-6	10	Trelleborg T-510	TT	337	143	1015	10	9	4.5"
TB1168500	13x5.00-6	4	Trelleborg T-510	TT	326	119	260	10	4.1	3.5"
TB1473000	220/50-6	73A6	Trelleborg T-510	TT	370	222	365	30	2.7	3.5"
WD5081356	13x5.00-6	4	Wanda P508	TL	322	120	210	16	2.7	3.5"
WD5081566	15x6.00-6	4	Wanda P508	TL	380	160	275	16	2.1	4"
TB1147700	15x6.00-6	6	Trelleborg T-510	TT	370	160	430	10	3.8	4"
DU2362	15x6.00-6	4	Duro HF-217	TL	360	155	260	30	2.1	4"
8"										
WD50816656	16x6.50-8	4	Wanda P508	TL	410	165	295	16	2	5.375"
TB10576300	16x6.50-8	3A8	Trelleborg T-510	TT	406	170	455	30	2.5	5.375"
STC19800330	16x9.50-8	76B	Starco HT	TT	416	224	400	50	2,3	7"
TB1470100	220/45-8 16x9.50-8	70A6	Trelleborg T-510	TT	410	220	475	30	2.8	7"
DU2020	18x8.50-8	4	Duro HF-217	TL	450	231	475	16	1.65	7"
12"										
TB1460300	300/65-12	118A8	Trelleborg T-446	TL	697	303	1400	40	2.5	9"

Kun utvalgte mønster er tatt med i liste. Sjekk nettbutikk for fullt sortiment. <https://b2b.norgesdekk.no>

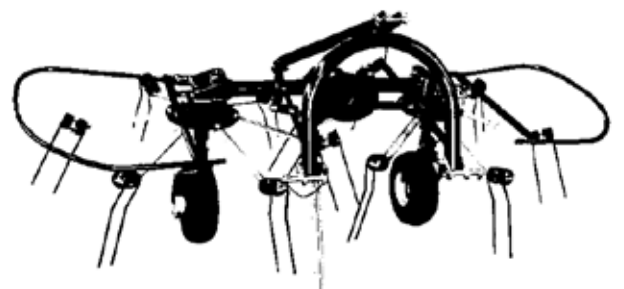

Wanda P508
Duro HF-217
Starco HT

Trelleborg
T-510

Trelleborg
T-446

TURF - GRESSDEKK GLATTBANE - FORHØSTERE ETC

PART #	Dimensjon	Pr (Li/Si)	Dekkmønster	TL/TT						
					mm	mm	kg	km/t	bar	Felg
4" Glattbane										
WD6074104	4.10/3.50-4	4	Wanda P607	TL	261	98	160	16	3,5	2,5"
S2130361	8x3.00-4	4	Dekk ST30	TT	216	73	80	16	4	2.1"
S2130378	9x3.50-4	4	Dekk ST30	TL	229	94	60	16	3.5	2.75"
5"										
WD6074105	4.10/3.50-5	4	Wanda P607	TL	288	96	180	16	3,5	2,5"
WD1145P607	11x4.00-5	2	Wanda P607	TL	277	103	156	16	3.2	3"
6"										
WD1356P607	13x5.00-6	4	Wanda P607	TL	323	123	210	16	2,8	3,5"
WD60713656	13x6.50-6	4	Wanda P607	TL	330	161	230	16	1,9	4,5"
8"										
TB1155200	4.00-8	6	Trelleborg T-522	TT	425	112	290	30	2.7	2.5"
DU2715	4.80/4.00-8	4	Duro HF-237	TT	410	107	225	30	2.7	2.5"
DU2726	5.00-8	6	Duro HF-237	TT	450	138	260	30	2.0	3"
TB1155400	5.00-8	6	Trelleborg T-522	TT	450	138	380	30	2.3	3"
MX1470C	19x10.50-8	4	Maxxis C-190	TL	475	250	365	16	1.65	8"
9"										
DU6009-237	6.00-9	6	Duro HF-237	TT	553	155	490	30	3.0	4"
10"										
WD6071810510	18x10.50-10	2	Wanda P607	TL						
WD607201010	20x10.00-10	2	Wanda P607	TL						
KE19211278	20x10.00-10	85A4	Kenda Smooth	TL	503	250	515	20	1,5	8.5"

Kun utvalgte mønster er tatt med i liste. Sjekk nettbutikk for fullt sortiment. <https://b2b.norgesdekk.no>



ST30
Wanda P607
Duro HF-237

Carlisle Smooth
Trelleborg T-522



PLENKLIPPERE - SMÅ HAGEMASKINER

PLEN - HAGEDEKK



	Dimensjon	Pr (Li/Si)	Dekkmønster	TL/TT	mm	mm	kg	km/t	bar	Felg
4"										
DU2344	4.10/3.50-4	4	Duro HF-201	TT	265	103	160	16	3.5	2.1"
WDP50129354	9x3.50-4	4	Wanda P5012	TL	229	94	105	16	3.5	2.1"
WD3321144	11x4.00-4	4	Wanda P332	TL	270	100	160	16	3.3	2.5"
DUB1403	11x4.00-4	4	Duro HF-217	TL	270	104	170	10	3.2	2.5"
DU2345	11x4.00-4	2	Duro DI-5001	TL	260	106	85	10	1.5	2.5"
CAR2500085	12x5.00-4	2	Carlisle Turf Pro	TL	292	122	116	16	1.52	3.25"
5"										
DU2352	4.10/3.50-5	4	Duro HF-201	TT	308	106	255	10	3.5	2.5"
WD3321144	11x4.00-5	4	Wanda P332	TL	276	100	150	16	3.25	3"
DU2354	11x4.00-5	2	Duro HF-224	TL	275	101	105	10	1.5	3"
6"										
DU2366	4.10/3.50-6	4	Duro HF-201	TT	315	102	275	10	3.5	2.5"
CAR12500125	8.00-6	6	Carlisle Turf Glide	TT	447	180	187	16	1.4	3.25"
DU2358	LP140-6	6	Duro HF-213	TT	334	135	310	16	5.5	4.5"
TB1194200	LP140-6	6	Trelleborg T-539	TT	325	134	845	10	7	4.5"
TB1300000	13x5.00-6	6	Trelleborg T-539	TL	320	122	325	10	4	3.5"
WD33213564	13x5.00-6	4	Wanda P332	TL	316	132	210	16	2.8	3.5"
DU2368	13x5.00-6	4	Duro HF-224	TL	320	122	200	10	1.9	3.5"
WD33213656	13x6.50-6	4	Wanda P332	TL	333	160	220	16	1.9	5"
WD3321566	15x6.00-6	4	Wanda P332	TL	380	160	275	16	2.1	4.5"
DU2369	15x6.00-6	4	Duro HF-224	TL	370	152	260	10	2.1	4.5"
DU2362	15x6.00-6	4	Duro HF-217	TL	366	155	260	16	2.1	4.5"
8"										
WDP3324008	4.80/4.00-8	4	Wanda P322	TL	421	119	320	16	2.9	3.5"
STC19800469	13x5.00-8	2 28A4	Starco Turf Grip	TL	330	124	100	20	0.8	4"
STC19800470	160/50-8 14x6.00-8	4 50A4	Starco Turf Grip Pro	TL	364	142	190	20	1.3	4.375"
WD332166584	16x6.50-8	4	Wanda P332	TL	410	165	295	16	1.9	5.375"
DU2380	16x6.50-8	4	Duro HF-224	TL	401	165	280	10	2	5.375"
TB1170000	16x6.50-8	6	Trelleborg T-539	TT	410	170	440	10	2.7	5.375"
TB1470600	170/60-8	47A8	Trelleborg High Grip	TL	406	166	340	40	1.4	5.375"
STC19800468	170/60-8 16x7.00-8	4 59A8	Starco Turf Grip Pro	TL	406	168	243	40	1.7	5.375"
TB1443500	16x7.50-8	4	Trelleborg T-537	TL	426	190	360	10	2	5.375"
WD33216758	16x7.50-8	4	Wanda P332	TL	410	182	325	16	1.6	5.375"
DU2376	16x7.50-8	4	Duro HF-275	TL	415	185	320	10	1.6	5.375"
DU2357	16x7.50-8 190LP8	2	Duro DI5001	TL	397	179	220	16	0.8	5.375"
TB1159500	190LP8	8	Trelleborg T-537	TT	426	184	700	10	5.8	5.5"
WDP5191788	17x8.00-8	2	Wanda P519	TL	423	184	210	16	0.6	5.5"
WD33218658	18x6.50-8	4	Wanda P332	TL	455	165	370	16	1.9	5"
DU2377	18x6.50-8	2	Duro HF-224	TL	448	165	250	10	1.1	5"

Kun utvalgte mønster er tatt med i liste. Sjekk nettbutikk for fullt sortiment. <https://b2b.norgesdekk.no>



Wanda P332
Kenda Super Turf
Duro DI-5005

Wanda P532
Duro HF-293

Wanda P5023

Wanda P519
Kenda K583
Trelleborg T-537

Carlisle Turf Pro

Carlisle Turf Glide

Carlisle Turf Mate

Carlisle Field Trax

PLENKLIPPERE - SMÅ HAGEMASKINER

PLEN - HAGEDEKK

PART
#



	Dimensjon	Pr (Li/Si)	Dekkmønster	TL/TT	mm	mm	kg	km/t	bar	Felg
8" Fortsetter										
WD3221878	18x7.00-8	4	Wanda P322	TL	450	177	356	16	1.8	5.375"
DU2359	18x7.50-8	2	Duro DI-5003	TL	458	192	360	16	1.7	5.375"
TB1194600	18x7.50-8	2	Trelleborg T-539	TL	462	190	250	10	1	5.375"
TB1470800	200/65-8	59A8	Trelleborg High Grip	TL	454	204	340	40	1.4	5.375"
WD33218858	18x8.50-8	4	Wanda P332	TL	455	210	390	16	1.5	7"
WD502318858	18x8.50-8	4	Wanda P5023	TL	450	213	395	16	1.5	7"
DU2381	18x8.50-8	4	Duro DI-5005	TL	445	210	370	10	1.5	7"
TB1149600	18x8.50-8	4	Trelleborg T-539	TL	475	220	480	10	1.6	7"
WD33218958	18x9.50-8	4	Wanda P332	TL	460	223	500	16	1.6	7"
DU2382	18x9.50-8	4	Duro HF-224	TL	465	218	370	10	1.5	7"
WD3322088	20x8.00-8	4	Wanda P332	TL	507	207	455	16	1.6	6.5"
DU2396	20x8.00-8	4	Duro DI-5005	TL	515	210	431	10	1.5	6.5"
WD33220108	20x10.00-8	4	Wanda P332	TL	500	250	570	16	1.6	8"
DU2383	20x10.00-8	4	Duro DI-5005	TL	505	245	520	10	1.5	8"
TB6150100	20x10.00-8	4	Trelleborg T-539	TL	530	260	600	10	1.5	8.5"
WD33422118	22x11.00-8	4	Wanda P334	TL	565	255	453	10	1.4	8.5"
WD532225108	22.5x10.00-8	4	Wanda P532	TL	587	243	590	16	1.4	7"
9"										
WD53225129	25x12.00-9	4	Wanda P532	TL	658	311	950	16	1.4	10"
WD302625139	25x13.00-9	4	Wanda P3026B	TL	657	319	893	-	1.4	10"
10"										
WD5023188510	18x8.50-10	4	Wanda P5023	TL	457	203	395	16	1.5	7"
WD3321810510	18x10.50-10	4	Wanda P332	TL	452	257	450	16	1.38	8"
WD502320810	20x8.00-10	4	Wanda P5023	TL	495	193	410	16	1.6	6"
TB1481200	250/50-10	79A8	Trelleborg High Grip	TL						
TB1150000	20x10.00-10	6	Trelleborg T-539	TL	516	260	700	10	2.3	8"
WD332201010	20x10.00-10	4	Wanda P332	TL	508	243	555	16	1.5	8"
WD5023201010	20x10.00-10	4	Wanda P5023	TL	508	254	560	16	1.5	8"
DUB1476	20x10.00-10	6	Duro HF-293	TL	508	250	660	10	2.1	8"
BK1477	20x12.00-10	4	BKT LG-307	TL	500	280	600	10	1.5	10"
KE19211282	20.5x8.00-10	4	Kenda Commercial Turf	TL	522	213	400	10	1.6	6"
WD532229510	22x9.50-10	4	Wanda P532	TL	572	243	560	16	1.4	7"
WD332221010	22x10.00-10	4	Wanda P332	TL	559	254	576	16	1.4	8"
WD322221110	22x11.00-10	4	Wanda P322	TL	556	268	670	16	1.5	8.5"
CAR12598014	24x9.50-10	4	Carlisle Turf Trac	TL	617	249	642	16	1.52	7"
CAR12500398	24x9.50-10	4	Carlisle All Trail II	TL	610	241	375	80	1.52	7.5"
WD30262410510	24x10.50-10	4	Wanda P3026B	TL	617	274	408	80	1.4	8"
WD532241210	24x12.00-10	4	Wanda P532	TL	641	280	775	16	1.4	10"

Kun utvalgte mønster er tatt med i liste. Sjekk nettbutikk for fullt sortiment. <https://b2b.norgesdekk.no>



Carlisle All Trail II

Carlisle Fast Trax

Carlisle Multi Trac

Kenda K384

Kenda K513
Commercial Turf

Kenda K506

Bridgestone PD1
Pillow Dia-1

Bridgestone FD
Farm Service Dia

STØRRE HAGEMASKINER

PLEN - HAGEDEKK



	Dimensjon	Pr (Li/Si)	Dekkmønster	TL/TT	mm	mm	kg	km/t	bar	Felg
12"										
GB132808	6.00-12	4	Bridgestone FD	TL	564	155	270	30	2	4"
GB261393	22x8.50-12	4	Bridgestone PD1	TL	546	216	505	15	1.6	7"
WD5023229512	22x9.50-12	4	Wanda P5023	TL	549	229	560	16	1.4	7"
WD3222310512	22x10.50-12	4	Wanda P332	TL						
WD332238512	23x8.50-12	4	Wanda P332	TL	588	215	535	16	1.5	7"
DU2386	23x8.50-12	4	Duro HF-224	TL	570	212	460	10	1.5	7"
WD5023239512	23x9.50-12	4	Wanda P5023	TL	577	237	590	16	1.4	7"
TB1472500	220/60-12	88A8	Trelleborg T-539	TL	578	220	650	40	1.7	7"
WD3322310512	23x10.50-12	4	Wanda P332	TL	590	250	642	16	1.4	8.5"
WD50232310512	23x10.50-12	4	Wanda P5023	TL	579	264	630	16	1.4	8.5"
WD30262310512	23x10.50-12	4	Wanda P3026	TL	590	235	453	16	1.4	7"
DU2388	23x10.50-12	4	Duro DI-5005	TL	575	245	607	10	1	8.5"
TB1227900	23x10.50-12	6	Trelleborg T-539	TL	572	272	900	10	2.2	8.5"
CS1673	24x8.50-12	4	CST C-165S	TL	608	216	510	10	1.7	7"
WD322249512	24x9.50-12	4	Wanda P332	TL	599	247	625	16	1.7	7"
WD322241212	24x12.00-12	4	Wanda P332	TL	610	295	515	16	0.36	8.5"
WD5023241212	24x12.00-12	4	Wanda P5023	TL	610	239	820	16	1.4	9.5"
DU2397	24x12.00-12	4	Duro DI-5005	TL	615	295	770	10	1.4	9.5"
WD5023261212	26x12.00-12	4	Wanda P5023	TL	648	307	845	16	1.4	10.5"
WD3322612128	26x12.00-12	8	Wanda P332	TL	655	310	1450	16	3.4	10.5"
DU2398	26x12.00-12	4	Duro DI-5005	TL	640	320	770	10	1.2	10.5"
DU2389	26x12.00-12	8	Duro HF-213	TL	661	325	1250	10	3.4	10.5"
TB1151000	26x12.00-12	8	Trelleborg T-539	TL	652	320	1400	10	3.4	10.5"
TB1470300	320/55-12	105A8	Trelleborg T-412	TL						
BK1678	26.5x14.00-12	6	BKT LG-408	TL	665	380	1280	16	2.0	10.5"
14"										
GB132822	6.00-14	4	Bridgestone FD	TT	614	155	305	30	2	5"
GB132846	7.00-14	4	Bridgestone FD	TT	660	175	370	30	1.8	5"
WD248514	24x8.50-14	4	Wanda P332	TL	602	215	540	10	1.5	7"
BK1681	25x8.50-14	6	BKT LG-306	TL	638	220	745	20	2.2	7"
GB2506014B	250/60-14	4 79A6	Bridgestone M40B	TL	656	246	437	30	1.6	7"



Bridgestone PD1
Pillow Dia-1

Bridgestone FD
Farm Service Dia

Bridgestone M40B

Carlisle Multi Trac

Galaxy Turf
Special R3

Galaxy Mighty Mov

Kenda K505 Turf

STØRRE HAGEMASKINER

PLEN - HAGEDÉKK



	Dimensjon	Pr (Li/Si)	Dekkmønster	TL/TT	mm	mm	kg	km/t	bar	Felg
15"										
GL383033	25x10.50LL15	6	Galaxy Turf Special R3	TL	643	262	455	15	0.7	8"
TI369150	25x10.50-15	6	Titan Soft Turf	TL						8"
BK1682	27x8.50-15	4	BKT LG-306	TL	680	216	730	10	2.1	7"
WD332278515	27x8.50-15	6	Wanda P332	TL						7"
BK1682A	27x10.50-15	4	BKT LG-306	TL	705	272	600	16	2.1	8.5"
BK1684	27x10.50-15	12	BKT LG-306	TL	705	272	1100	16	6.1	8.5"
WD3322710515	27x10.50-15	8	Wanda P332	TL						8.5"
DU2399	27x12.00-15	4	Duro DI-5005	TL	680	292	890	10	2.1	10"
CAR12598058	28x8.50-15	4	Carlisle Multi Trac	TL	711	213	650	50	2	7"
GB134185	29x12-15	4	Bridgestone PD1	TL	757	297	810	16	1.4	10"
WD3322912515	29x12.50-15	10	Wanda P332	TL						10"
TB1440300	320/55-15 29x12.5-15	123A8	Trelleborg T-559	TL	730	320	1620	40	2.7	10"
WD512291415	29x14.00-15	8	Wanda P512	TL						
WD3323113515	31x13.50-15	4	Wanda P332	TL						10"
TB1467300	31x15.50-15	8	Trelleborg T-412	TL						10"
BK1680	31x15.50-15	8	BKT Tracmaster	TL	810	403	1250	10	3	10"
WD5323115515	31x15.50-15	8	Wanda P532	TL						10"
TB1472100	380/60-15 33x15-15	114A8	Trelleborg T-539	TL						10"
TB1466400	33x15.50-15	6	Trelleborg T-412	TL						10"
CAR132266	36x13.50-15	4	Carlisle Multi Trac	TL	914	381	1182	16	1.3	10"
KE19211357	212/80-15	79A6	Kenda K505 Turf	TL	721	217	437	30	1.6	7"
GB151359	315/75D15	4	Bridgestone M40B	TL	853	316	615	30	1	10"
16"										
GB1784	8.00-16	4	Bridgestone FD	TT	805	210	475	30	1.6	5"
GB132907	9.50-16	4	Bridgestone FD	TT	820	242	555	30	1.4	8"
WD53213616	13.6-16	4	Wanda P532	TL						12"
BK3325	13.6-16	4	BKT LG-306	TL	975	388	950	16	1.0	12"
GB3158016	315/80-16	⁶ 94A6	Bridgestone M40B	TL			900	30	1.6	10"
16,1"										
	21.5L16.1	4	Carlisle Multi Trac	TL	1134	546	1596	48	0.8	18"
GL381848	22.5LL16.1	6	Galaxy Turf Special R3	TL	1133	582	1690	15	0.4	18"
16,5"										
GL383040	10-16.5	8	Galaxy Mighty Mow	TL						
18"										
GB132914	9.50-18	4	Bridgestone FD	TT	870	242	600	30	1.4	8"
20"										
WD332411420	41x14.00-20	4	Wanda P332	TL						11"
WD332441820	44x18.00-20	6	Wanda P332	TL						14"
BKB1699	44x18.00-20	4	BKT LG-306	TL	1180	475	1500	10	1	14"
GB134376	355/80-20	4	Bridgestone PD1	TT	1076	353	825	16	1	11"
GB19800248	475/65-20	4	Bridgestone PD1	TT	1126	464	1180	16	0.8	15"
24"										
GB11224PR4FD	11.2-24	4	Bridgestone FD	TT	1071	275	845	30	1.2	9"
GL383088	17.5-24	8	Galaxy Mighty Mow	TL						

Kun utvalgte mønster er tatt med i liste. Sjekk nettbutikk for fullt sortiment. <https://b2b.norgesdekk.no>

GOLFBANE-BILER OG GO-KART

PLEN - HAGEDDEKK

PART #	Dimensjon	Pr (Li/Si)	Dekkmønster	TL/TT	mm	mm	kg	km/t	bar	Felg										
6"																				
CAR12500125	8.00-6	6	Carlisle Turf Glide	TT	447	180	187	16	1.4	3.25"										
8"																				
WD815165658	16.5x6.50-8	6 73M	Wanda P815	TL	415	175	375	130	4.5	5.375"										
KE19211193	18x6.50-8	6	Kenda K389 Hole-N-1	TL	453	163	430	16	2.76	5"										
WD50918858	18x8.50-8	6	Wanda P509	TL	455	212	504	30	2.3	7"										
10"																				
WD823195010	195/50B10	98N	Wanda P823	TL	460	185	750	140	6	6"										
WD8262055010	205/50-10 18x8.00-10	49K	Wanda P826	TL	460	198	185	110	1	5,5"										
WD826254510	225/45-10 18x9.00-10	50K	Wanda P826	TL	460	216	190	110	1	6"										

Kun utvalgte mønster er tatt med i liste. Sjekk nettbutikk for fullt sortiment. <https://b2b.norgesdekk.no>



GO-KART DEKK

PART #	Dimensjon	Pr (Li/Si)	Dekkmønster	Pris	TL/TT	mm	mm	kg	km/t	bar	Felg									
5"																				
SPS2686	10x4.50-5	4	HF-242B	364,-	TL	254	126			1.0	4.5"									
SPS2688	11x7.10-5	4	HF-242B	516,-	TL	278	210			1.0	8"									

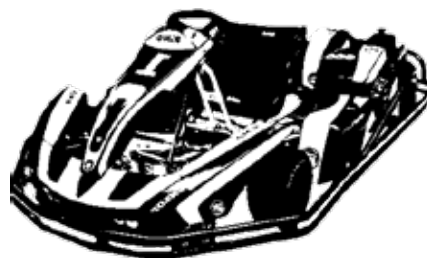

Carlisle Turf Glide

Kenda K389 Hole-N-1

Kenda K399 Load Star

Wanda P815

Wanda P509

Wanda P826

SNØFRESERE OG PREPARERINGSMASKINER

SNØFRESEERDEKK

PART #	Dimensjon	Pr (Li/Si)	Dekkmønster	TL/TT	mm	mm	kg	km/t	bar	Felg
4"										
WD5016414	4.10-4	2	Wanda P5016 Snow Hog	TL	268	102	102	10	1.7	3.75"
DU2343	4.10/3.50-4	2	Duro HF-271	TL	275	100	104	10	1.7	2.5"
6"										
WD50164106	4.10-6 13x4.00-6	2	Wanda P5016 Snow Hog	TL	325	102	131	10	1.7	3.25"
WD1346P533	13x4.00-6 4.10/3.50-6	2	Wanda P533 Snow Blower	TL	311	99	135	10	1.5	3.25"
WD50161356	13x5.00-6	2	Wanda P5016 Snow Hog	TL	328	122	131	10	1.4	3.5"
DU2364	13x5.00-6	2	Duro HF-271	TL	335	102	150	10	1.4	3.5"
DU2393	14x4.00-6	2	Duro HF-270	TL	358	109	150	10	0.5	3"
WD1556P533	15x5.00-6	2	Wanda P533 Snow Blower	TL	360	120	195	10	1.4	3.5"
8"										
WD501648	4.80/4.00-8	2	Wanda P5016 Snow Hog	TL	423	121	200	10	1.4	3.75"
WD53348	4.80/4.00-8	4	Wanda P533 Snow Blower	TL	424	114	208	10	1.4	3.75"
DU2363	4.80/4.00-8	2	Duro HF-271	TL	400	98	220	10	1.4	3.75"
WD501616658	16x6.50-8	4	Wanda P5016 Snow Hog	TL	406	165	186	10	1.9	5.375"
WD16658P533	16x6.50-8	4	Wanda P533 Snow Blower	TL	406	160	295	10	1.9	5.375"
DU2373	16x6.50-8	2	Duro HF-279	TL	401	165	210	10	0.7	5.375"
CAR64660	18x6.50-8	4	Carlisle Snow Hog	TL	439	168	350	10	0.93	5.375"

Kun utvalgte mønster er tatt med i liste. Sjekk nettbutikk for fullt sortiment. <https://b2b.norgesdekk.no>

DEKK TIL PREPARERINGSMASKINER

PART #	Dimensjon	Pr (Li/Si)	Dekkmønster	TL/TT	mm	mm	kg	km/t	bar	Felg
12"										
TB1158700	560x140-12	100A4	Trelleborg T-528	TT	556	139	800	20	8	
MIT4920242	5.50-12 560x140-12	93A6 10	Mitas ST Snowtrac	TT	562	133	650	20	5.5	
13"										
TB1158800	610x145-13	112A2	Trelleborg T-528	TT	610	153	1120	20	7.9	
14"										
TB1158900	645x160-14	120A2	Trelleborg T-528	TT	643	160	1400	20	8	

Kun utvalgte mønster er tatt med i liste. Sjekk nettbutikk for fullt sortiment. <https://b2b.norgesdekk.no>

TRELLEBORG



Wanda P533
Snow Blower
Duro HF-279



Dekk ST49
Carlisle Snow Hog
Duro HF-271



Duro
HF-270



Trelleborg
T-522



Trelleborg
T-528

TILHENGERE - CAMPINGVOGNER

DEKK



	Dimensjon	Li/Si	Dekkmønster	TL/TT	mm	mm	kg	km/t	bar	Felg
6"										
TB1159100	4.10/3.50-6	57J	Trelleborg T-533	TL	315	94	225	100	4.5	2.5"
8"										
TB1147100	4.00-8	71J	Trelleborg T-49	TL	418	115	340	100	6	2.5"
TB100217	4.00-8	6	Trelleborg Unitester 520	TL	418	115			7	2.5"
DU2510	4.80/4.00-8	70M	Duro HF-215	TL	409	106	335	130	5	2.5"
WD81148	4.80/4.00-8	71M	Wanda P811	TL	418	120	345	130		2.5"
DU2520	5.70/5.00-8	76M	Duro HF-215	TL	469	146	400	130	5	3"
WD81158	5.70/5.00-8	83M	Wanda P811	TL	460	155	487	130	4.9	3.75"
WD815165658	16.5x6.50-8	73M	Wanda N699 P815	TL	415	175	365	130	4.9	5.375"
TB11233600	16.5x6.50-8	72J	Trelleborg T-539	TL	411	165	360	100	4.9	5.375"
DU2525	16.5x6.50-8	64M	Duro HF-232	TL	416	164	280	130	3.2	5.375"
WD815185858	18.5x8.50-8	83M	Wanda P815	TL	480	213	498	130	3.5	7"
9"										
DU2530	6.00-9	84M	Duro HF-219	TL	545	165	500	130	3.9	4"
DU2531	6.00-9	91M	Duro HF-219	TL	545	175	615	130	5.9	4"
TB6158600	6.00-9	99J	Trelleborg T-523	TL	540	165	800	100	8	4"
10"										
TB1467900	4.40-10	62J	Trelleborg T-690	TT						
WD80250010	5.00-10	79N	Wanda P802	TL	508	137	463	130	3,4	3"
DU2551	5.00-10	73J	Duro HF-249	TL	509	148	370	100	3.1	3"
DU2561	5.20-10	63J	Duro HF-268	TL	500	140	270	100	2.1	3.5"
WDWR06814510	145R10	84N	Wanda WR068 (M+S)	TL	480	135	500	140	2.7	3.5"
KE19266064	145R10	74N	Kenda KargoTrail 3G (M+S)	TL						
WD823195010	195/50B10	98N	Wanda P825	TL	460	185	750	140	6	6"
WD1955510WR068	195/55R10 18x8.00R10	98P	Wanda WR068 (M+S)	TL	460	185	750	150	6	6"
KE19266081	195/55R10 18x8.00R10	98N	Kenda KR500 Winter Trailer (M+S m/pigghull)	TL	460	185	750	140	6	6"
WD205810P825	20.5x8.00-10 205/65-10	90M	Wanda P825	TL	520	205	600	130		6"
KE128610	20.5x10.00-10 255/50-10	98M	Kenda K399	TL	524	253	750	130	6	8"

Kun utvalgte mønster er tatt med i liste. Sjekk nettbutikk for fullt sortiment. <https://b2b.norgesdekk.no>



ST20
Kenda K303

ST80
Wanda P811
Duro HF-215

ST89
Kenda K385

ST85
Wanda P815

Wanda P802

Wanda H1022

Wanda WR068

Linglong R701

TILHENGERE - CAMPINGVOGNER

DEKK

PART
#



	Dimensjon	Li/Si	Dekkmønster	TL/TT	mm	mm	kg	km/t	bar	Felg
12"										
WD4812P811	4.80-12	80M	Wanda P811	TL	520	118	450	130	6	3"
WD1557012WR068	155/70R12	104N	Wanda WR068 (M+S)	TL	523	152	900	140	6.5	4"
KE9266100	155/70R12	104N	Kenda KR500 Winter Trailer (M+S m/pigghull)	TL	523	152	900	140	6.5	4"
GTR100AK030	155/70R12	104N	GT Radial KargoMax ST-6000 (M+S)	TL	523	152	900	140	6.5	4"
WD1856012WR068	185/60R12	104N	Wanda WR068 (M+S)	TL	525	186	900	140	6.5	6"
KE19266105	185/60R12	104N	Kenda KR500 Winter Trailer (M+S u/pigghull)	TL	525	186	900	140	6.5	6"
GTR280714	185/60R12	104N	GT Radial KargoMax ST-6000 (M+S)	TL	525	186	900	140	6.5	6"
GTR100AK004	195/60R12	104N	GT Radial KargoMax ST-6000 (M+S)	TL	530	194	900	140	6.6	6"
WD1956012WR068	195/60R12	104N	Wanda WR068 (M+S)	TL	530	194	900	140	6.6	6"
KE128962	225/55B12	112N	Kenda K399 Load Star	TL	555	225	1120	140	7	7"
13"										
GTR19866014	145R13	79N	GT Radial KargoMax ST-4000 (M+S)	TL	562	145	437	140	3	4"
GTR100AK010	155R13	84N	GT Radial KargoMax ST-4000 (M+S)	TL	578	157	500	140	3.1	4.5"
KE19266117	155R13	84N	Kenda KargoTrail 3G (M+S)	TL	578	157	600	180	4.5	4.5"
WDWR0821551391	155R13	91N	Wanda WR082 (M+S)	TL	578	157	615	140	3.1	4.5"
GTR100AK027	155R13	91N	GT Radial KargoMax ST-6000 (M+S)	TL	578	157	615	140	4.5	4.5"
KE19266109	155R13	91N	Kenda KR500 Winter Trailer (M+S m/pigghull)	TL	578	157	615	140	4.5	4.5"
GTR100AK002	165R13	96N	GT Radial KargoMax ST-6000 (M+S)	TL	598	167	710	140	4.5	4.5"
WDWR08216513	165R13	96N	Wanda WR082 (M+S)	TL	598	167	710	140	4.5	4.5"
KE19266121	165R13	96N	Kenda MasterTrail 3G (M+S)	TL	598	167	710	140	4.5	4.5"
GTR100A004	175R13	97N	GT Radial Maxmiler X	TL	610	178	730	140	4.5	5"

13" fortsetter neste side

Kun utvalgte mønster er tatt med i liste. Sjekk nettbutikk for fullt sortiment. <https://b2b.norgesdekk.no>



Kenda K399
Load Star

Kenda KR06
Koyote

GT Radial
Kargomax ST4000

GT Radial
Kargomax ST6000

Antares
SU810

Antares
SU830

GT Radial
Maxmiler X

GT Radial
Maxmiler PRO

TILHENGERE - CAMPINGVOGNER

DEKK



	Dimensjon	Li/Si	Dekkmønster	TL/TT	mm	mm	kg	km/t	bar	Felg
13"										
GTR100AK011	145/70R13	78N	GT Radial KargoMax ST-4000 (M+S)	TL	534	150	425	140	3.2	4.5"
GTR100AK012	155/70R13	78N	GT Radial KargoMax ST-4000 (M+S)	TL	548	157	425	140	3.1	4.5"
KE19266118	165/70R13	79N	Kenda KargoTrail 3G (M+S)	TL	562	170	437	140	2.6	5"
GTR100AK013	165/70R13	80N	GT Radial KargoMax ST-4000 (M+S)	TL	562	170	450	140	2.6	5"
KE19266119	175/70R13	86N	Kenda KargoTrail 3G (M+S)	TL	578	177	530	140	3.4	5"
GTR261508	185/70R13	106N	GT Radial Savero (M+S)	TL	596	194	950	140	6	5.5"
GTR100AK028	185/70R13	93N	GT Radial KargoMax ST-4000 (M+S)	TL	590	189	600	140	3.1	5.5"
WD1955013WR068	195/50R13	104N	Wanda WR068 (M+S)	TL	526	201	900	140	6.5	6"
KE19266110	195/50R13	104N	Kenda KR500 Winter Trailer (M+S m/pigghull)	TL	526	195	900	140	6.5	6"
GTR100AK032	195/50R13	104N	GT Radial KargoMax ST-6000 (M+S)	TL	526	201	900	140	6.5	6"
14"										
KE19266132	175R14	99N	Kenda MasterTrail 3G (M+S)	TL	637	175	775	140	4.5	5"
GTR100AK003	185R14	104N	GT Radial KargoMax ST-6000 (M+S)	TL	650	188	900	140	4.5	5.5"
KE19266134	185R14	104N	Kenda MasterTrail 3G (M+S)	TL	650	188	900	140		5.5"
KE19266130	185/65R14	93N	Kenda KargoTrail 3G (M+S)	TL	600	192	600	140	3.2	5.5"
GTR100AK029	185/65R14	93N	GT Radial KargoMax ST-4000 (M+S)	TL	596	189	650	140		5.5"
KE19266135	195R14	108N	Kenda MasterTrail 3G (M+S)	TL	666	198	1000	140	5	5-6"
GTR100AK016	195/70R14	96N	GT Radial KargoMax ST-4000 (M+S)	TL	630	201	710	140	3.1	6"
KE19266131	195/70R14	98N	Kenda KargoTrail 3G (M+S)	TL	630	202	710	140	3	6"
GTR100AK005	195/70R14	104N	GT Radial KargoMax ST-6000 (M+S)	TL	630	201	900	140	4.5	6"
KE19266136	205R14	109N	Kenda MasterTrail 3G (M+S)	TL	686	205	1030	140	4.5	6"
KE19266137	215R14	116N	Kenda MasterTrail 3G (M+S)	TL	700	312	1250	140	4.75	6"
15"										
GTR384221	195/65R15	95N	GT Radial KargoMax ST-4000 (M+S)	TL	635	201	690	140	3	6"

Kun utvalgte mønster er tatt med i liste. Sjekk nettbutikk for fullt sortiment. <https://b2b.norgesdekk.no>



GT Radial
Kargomax ST4000

GT Radial
Kargomax ST6000

GT Radial
Savero

Boka Trailer
Line FT01

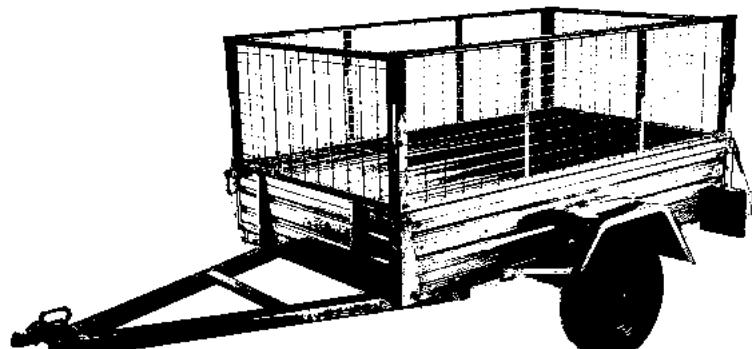

TILHENGERE - CAMPINGVOGNER FELGER ALUMINIUM



	Felgdesign	Felg bredde	Felg diameter	Bolthull	Boltsirkel	nav	ET	kg	Farge
13"									
SETD230-0HS5S	Sento X-Load	4.5"	13"	4	100	57,1	30	800	Hyper Silver
SETD830-0HS14S	Sento X-Load	4.5"	13"	5	112	67,1	30	800	Hyper Silver
SETRD230-0S5S	Sento Trailer	5.5"	13"	4	100	57,1	30	800	Silver
SETRD830-0S14S	Sento Trailer	5.5"	13"	5	112	66.5	30	800	Silver
14"									
SETI230-0HS5S	Sento X-Load	5.5"	14"	4	100	57,1	30	1030	Hyper Silver
SETI830-0HS14S	Sento X-Load	5.5"	14"	5	112	67,1	30	1030	Hyper Silver
SETRI230-0S5S	Sento Trailer	5.5"	14"	4	100	57,1	30	800	Silver
SETRI830-0S14S	Sento Trailer	5.5"	14"	5	112	66.5	30	800	Silver
15"									
SETI830-0HS14S	Sento X-Load	6"	15"	5	112	67,1	30	1030	Hyper Silver
SETRL830-0S14S	Sento Trailer	6"	15"	5	112	66,5	30	800	Silver



SENTO TRAILER OG X-LOAD
PERFEKT FOR TILHENGERE,
CAMPINGVOGNER OG BÅT-TRALLER.
UNNGÅ PROBLEMER MED AT STÅLFELGENE
RUSTER I STYKKER



SMÅ TRAKTORER - TOHJULSTRAKTORER ETC.

DRIVDEKK DIAGONAL



	Dimensjon	Li/Si	Dekkmønster	TL/TT	mm	mm	kg	km/t	bar	Felg
4"										
DU2622	3.00-4	4	Duro HF-242	TT	270	80	120	30	3.2	2.1"
DU2623	4.00-4	4	Duro HF-242	TT	310	100	150	40	2.8	2.1"
5"										
SPS16811130	3.50-5	2	Sett ST40 inkl slange (TR87)	TT	310	91	70	16	1.25	2.5"
6"										
KE129662	4.10/3.50-6	4	Kenda K357	TT	340	94	165	16	2.9	3.5"
DU3506-252	3.50-6	4	Duro HF-252	TT	315	102	275	10	2.5	3.5"
WD3281356	13x5-6	2	Wanda P328 Nr.45	TL	330	118	165	16	1.4	3.5"
DU2625	13x5-6	2	Duro HF-242	TL	335	120	200	30	2.8	3.5"
8"										
SPS308982	3.00-8	2	Dekk ST40	TT						2.5"
DU2611	3.50-8	4	Duro HF-242	TT	385	95	180	30	1.9	2.5"
WDH80224808	4.80/4.00-8	4	Wanda H8022 ST40	TL	438	110	155	16	2.2	2.5"
DU2610	4.80/4.00-8	4	Duro HF-242	TT	425	107	225	30	2.8	2.5"
KE129976	4.80/4.00-8	4	Kenda Dekk ST40	TT	416	120	155	16	2.2	2.5"
T2128269	16x6.50-8	4	Dekk ST45	TL	369	165	280	40	1.9	5.375"
WD32816658	16x6.50-8	4	Wanda P328 Nr.45	TL	369	165	180	40	1.9	5.375"
T2265421	17x8-8	4	Kenda K359	TL	453	188	370	16	1.5	5.375"
KE330273	18x8-8	4	Kenda K359	TL	440	210	370	16	1.52	7"
SPS377162	18x8.50-8	4	Dekk ST45	TL	457	213	371	16	1.5	7"
KE150611	18x9.50-8	4	Kenda Dekk ST40	TL	473	234	470	16	1.65	7"
WD32818958	18x9.50-8	2	Wanda P328 Nr.45	TL	455	222	470	16	1.6	7"
DU2613	18x9.50-8	4	Duro HF-255	TL	465	218	470	10	1.6	7"
WD32820108	20x10.00-8	4	Wanda P328 Nr.45	TL	515	242	540	16	1.5	7"
KE270654	21x11-8	4	Kenda K472 Chevron Bar	TL	538	277	651	16	1.52	8.5"
DUB1489C	21x11-8	4	Duro HF-255	TL	539	285	157	50	0,4	8.5"
10"										
DU40010-253	4.00-10	4	Duro HF-253	TT	485	115	165	30	2.1	3.5"
DU2615	4.00-10	4	Duro HF-242	TT	485	115	165	30	2.1	3.5"
WDH802950010	5.00-10	6	Wanda H8029 ST41	TL	528	136	280	16	2.8	3.5"
SXTK103	5.00-10	58A6	Starmaxx TR-60	TT	528	136	224	30	2.5	3.5"
DU2616	5.00-10	4	Duro HF-242	TT	550	126	250	30	2.2	3.5"
TB6156400	5.00-10	8	Trelleborg T-462	TL	537	144	670	10	5.1	3.5"
CAR264707	18x8.50-10	4	Carlisle NHS Tru Power	TL	460	193	378	16	1.52	6"
STC128719	20x8.00-10	4	Starco AS Loader (ST45)	TL	520	196	410	40	1.6	6"
12"										
DU2617	4.00-12	4	Duro HF-252	TT	526	112	300	30	2.8	3"
T2130286	5.00-12	4	Dekk ST41	TT	584	146	300	16	2.8	4"
GB132761	5.00-12	4	Bridgestone FSL	TT	550	123	220	30	2.4	4"

Kun små diagonaldekk er tatt med i liste. Sjekk nettbutikk for fullt sortiment. <https://b2b.norgesdekk.no>



ST40
Kenda K357
Wanda H8022

Duro HF-252

Kenda K359

ST45
Wanda P328

Starmaxx TR60

SMÅ TRAKTORER - TOHJULSTRAKTORER ETC. DRIVDEKK DIAGONAL



	Dimensjon	Li/Si	Dekkmønster	TL/TT	mm	mm	kg	km/t	bar	Felg
DU2618	5.00-12	4	Duro HF-242	TT	585	128	315	30	2.2	4"
DU2619	5.00-12	4	Duro HF-242	TT	625	152	325	30	1.8	4"
WDH167612	6.00-12	4	Wanda H440 ST40	TL	562	147	272	16	1.9	5"
T2336824	6.00-12	4	Dekk ST41	TT	620	154	325	16	1.75	5"
SXTK126	6.50-12	6	Starmaxx TR-55	TL	588	163	490	30	2.4	5"
SXTK122	6.50-12	6	Starmaxx TR-60	TT	588	163	490	30	2.4	5"
SXTK132	7.00-12	6	Starmaxx TR-60	TT	685	198	690	30	3.1	5"
SW712G	7.00-12	6	Speedways Gripping	TT	685	198	690	30	3.1	5"
SPS370293	11/65-12	8	Dekk ST44	TL	700	273	1180	30	2.9	9.75"
T2126098	23x8.50-12	4	Dekk ST45	TL	584	208	500	40	1.4	7"
DUB1483	23x8.50-12	4	Duro HF-255	TL	584	208	500	40	1.4	7"
T2278384	23x8.50-12	6	Dekk ST45	TL	574	213	650	150	2.3	7"
DUB1478	23x10.50-12	4	Duro HF-255	TL	570	263	608	30	1.3	7"
WD3282310512	23x10.50-12	4	Wanda P328 Nr.45	TL	585	260	609	30	1.4	8.5"
T2133911	23x10.50-12	6	Dekk ST45	TL	592	244	800	30	2.25	8.5"
STC380216	23x10.50-12	8	Starco AS Loader (ST45)	TL	580	262	975	40	2.5	8.5"
TB1464900	23x10.50-12	10	Trelleborg T-463	TL	574	272	1300	10	4.5	8.5"
KE270975	24x12-12	4	Kenda K472 Chevron Bar	TL	600	302	775	15	1.4	8.5"
T2193199	26x12-12	10	Dekk ST45	TL	665	290	1400	40	3.6	10.5"
DU5414	26x12-12	6	Duro HF-255	TL	660	305	1210	30	2.7	10.5"
TB5412	26x12-12	4	Trelleborg T-463	TL	654	317	900	10	1.4	10.5"
TB5565	26x12-12	4	Trelleborg T-411	TL	646	320	900	10	1.4	10.5"
WD310261212	26x12-12	8	Wanda P310	TL	665	300	1372	16	3.4	10.5"
T2132389	26x12-12	8	Dekk ST45	TL	655	320	1370	16	3.4	10.5"
TB148070700	320/60-12	132A8	Trelleborg T-421	TT	689	320	2500	40	4.1	10.5"
14"										
T2134536	4.50-14	4	Dekk ST45	TT	600	124	185	25	1	3"
GB58014	5.00-14	4	Bridgestone FSL	TT	605	128	250	16	2.5	4"
X119800160	6.00-14	6	Deestone D-402 B	TT	655	157	300	30	2	5"
GB68014	6.00-14	4	Bridgestone FSL	TT	653	155	305	16	2	5"

Kun små diagonaldekk er tatt med i liste. Sjekk nettbutikk for fullt sortiment. <https://b2b.norgesdekk.no>



Bridgestone FSL

Starmaxx TR55

Wanda P310

KUN DE MINSTE AV VÅRE LANDBRUKSDEKK ER
LISTET HER. SJEKK VÅR NETTbutikk FOR ALLE
MERKER OG STØRRELSER

SMÅ TRAKTORER - TOHJULSTRAKTORER ETC.

DRIVDEKK DIAGONAL



	Dimensjon	Li/Si	Dekkmønster	TL/TT	mm	mm	kg	km/t	bar	Felg
SPS290539	7.00-14	4	Dekk ST44 AST	TL	690	170	375	30	1.8	5"
GB78014	7.00-14	4	Bridgestone FSL	TT	687	170	370	16	1.8	5"
15"										
SXTK150	5.00-15	6	Starmaxx TR-60	TT				30		4"
T2152677	5.00-15	6	Dekk ST45	TT	655	140	560	30	3.5	4"
T2134666	6.50-15	6	Dekk ST45	TT	678	163	750	30	3.6	5"
T2151205	7.50-15	6	Dekk ST45	TT	765	210	1215	40	5	6"
CAR265292	29x12.50-15	6	Carlisle NHS Tru Power	TL	744	295	776	16	2.07	10"
TB1440200	320/55-15	133A8	Trelleborg T-421	TL	735	315	2250	40	4	10"
MIT1013302630000	31x15.50-15	8	Mitas TR-07	TL						13"
T2271842	31x15.50-15	10	Dekk D316	TT						13"
SW3115515T10	31x15.50-15	10	Speedways Trencher	TL						13"
SST3115515R1	31x15.50-15	12	SeaStar R1	TL						13"
CAR265315	31x15.50-15	8	Carlisle NHS Tru Power	TL	798	384	1256	16	3.1	13"
TB33125156413	33x12.50-15		Trelleborg T413	TL						10"
15,3"										
SW1075153GHD	10x75-15,3	14	Speedways Gripping HD	TL						9"
SW1075153G	10x75-15,3	10	Speedways Gripping	TL						9"
SXTK514	10x75-15,3	12	Starmaxx TR-60	TT				30		9"
SXTK534	11.50-15,3	12	Starmaxx TR-60	TT				30		9"
SW11515314	11.50-15,3	14	Speedways Gripping HD	TL						9"
16"										
T2137940	6.00-16	8	Dekk ST45	TT						4.5"
SXTK200	6.00-16	6	Starmaxx TR-60	TT				30		4.5"
SXTK230	6.50-16	6	Starmaxx TR-60	TT				30		4.5"
SXTK270	7.50-16	8	Starmaxx TR-60	TT				30		5.5"
SW816G10	8.00-16	10	Speedways Gripping	TT						7"
SW67516G	9/75-16	10	Speedways Gripping HD	TL						7"
SW97016G	9/70-16	10	Speedways Gripping	TT						7"
SW139543ND	9.50-16	6	Speedways Gripping	TT						7"
17"										
SW194517	19/45-17	14	Speedways Gripping	TT						16"
18"										
SXTK320	7.00-18	8	Starmaxx TR-60	TT				30		5.5"
SXTK340	7.50-18	8	Starmaxx TR-60	TT				30		5.5"
SXTS332	7.50-18	8	Starmaxx TR-50	TT				30		5.5"
SW818G6	8.00-18	6	Speedways Gripping	TT						6"
SW105801810	10.50-18	10	Speedways Gripping HD	TL						8"
4"										
SPS129549	3.00-4	4	Dekk ST32 Sett DIN7777	TT	260	83	170	16	3.3	2.1"
SPS130828	4.00-4	4	Dekk ST32 Sett TR87	TT	304	114	155	16	2.75	3"
6"										
SPS130774	3.50-6	4	Dekk ST32 Sett TR87	TT	332	95	165	16	3	2.5"

Kun små diagonaldekk er tatt med i liste. Sjekk nettbutikk for fullt sortiment. <https://b2b.norgesdekk.no>



ST40
Kenda K357
Wanda H8022

Duro HF-252

Kenda K359

ST45
Wanda P328

Starmaxx TR60

Bridgestone FSL

Starmaxx TR55

Wanda P310

SMÅ TRAKTORER

FRONTDEKK 3-RIB 4" T.O.M 15"



	Dimensjon	Li/Si	Dekkmønster	TL/TT	mm	mm	kg	km/t	bar	Felg
8"										
SPS130804	3.50-8	4	Dekk ST32 Sett TR13	TT	385	91	190	16	2.75	2.5"
SPS130008	4.00/4.80-8	4	Dekk ST32 Sett TR13	TT	425	110	225	16	2.8	2.5"
12"										
SW412F2	4.00-12	4	Speedways F2	TT						
15"										
SW480153	4.00-15	4	Speedways SW201	TT						
SW515F2	5.00-15	6	Speedways F2	TT						
TB136.21.060	5.00-15	4	Trelleborg TD27	TT						

Kun små diagonaldekk er tatt med i liste. Sjekk nettbutikk for fullt sortiment. <https://b2b.norgesdekk.no>



Dekk ST32
Speedways F2

Trelleborg TD27
Speedways SW201

OBOR TERRENG GUIDE							
							
		STEIN	HARDT UNDERLAG	INTERMEDIATE	LØS LEIRJORD	SAND	GJØRME
ATV SPORT	ADVENT	<input type="checkbox"/>	<input type="checkbox"/>	<input type="checkbox"/>	<input type="checkbox"/>	<input type="checkbox"/>	<input type="checkbox"/>
	ADVENT MX	<input type="checkbox"/>	<input type="checkbox"/>	<input type="checkbox"/>	<input type="checkbox"/>	<input type="checkbox"/>	<input type="checkbox"/>
ATV UTILITY	CORNELIUS	<input type="checkbox"/>	<input type="checkbox"/>	<input type="checkbox"/>	<input type="checkbox"/>	<input type="checkbox"/>	<input type="checkbox"/>
	CYPRESS	<input type="checkbox"/>	<input type="checkbox"/>	<input type="checkbox"/>	<input type="checkbox"/>	<input type="checkbox"/>	<input type="checkbox"/>
	RIPLE	<input type="checkbox"/>	<input type="checkbox"/>	<input type="checkbox"/>	<input type="checkbox"/>	<input type="checkbox"/>	<input type="checkbox"/>
	HOWLER	<input type="checkbox"/>	<input type="checkbox"/>	<input type="checkbox"/>	<input type="checkbox"/>	<input type="checkbox"/>	<input type="checkbox"/>
	CRAWLER	<input type="checkbox"/>	<input type="checkbox"/>	<input type="checkbox"/>	<input type="checkbox"/>	<input type="checkbox"/>	<input type="checkbox"/>
	BRAWLER	<input type="checkbox"/>	<input type="checkbox"/>	<input type="checkbox"/>	<input type="checkbox"/>	<input type="checkbox"/>	<input type="checkbox"/>
	ANTELOPE	<input type="checkbox"/>	<input type="checkbox"/>	<input type="checkbox"/>	<input type="checkbox"/>	<input type="checkbox"/>	<input type="checkbox"/>
	MUDSLING	<input type="checkbox"/>	<input type="checkbox"/>	<input type="checkbox"/>	<input type="checkbox"/>	<input type="checkbox"/>	<input type="checkbox"/>
	SCORPIO	<input type="checkbox"/>	<input type="checkbox"/>	<input type="checkbox"/>	<input type="checkbox"/>	<input type="checkbox"/>	<input type="checkbox"/>

obor
**BASED ON INCREASING
 PERFORMANCE IN
 EVERY TERRAIN**

FØLG OBORTIRES PÅ FACEBOOK OG INSTAGRAM





obor **ADVENT** WP03 / WP04

OBOR Advent; mønster og premium gummiblanding for optimalt grep og presis styring.



TOPP SELGER!



Varenummer	Dimensjoner	PR	Li/SI	Mønster Dybde	Felg
OBP03210710	21x7-10	6	30F	15mm	5,5"
OBP03220710	22x7-10	6	33F	15mm	5,5"

Varenummer	Dimensjoner	PR	Li/SI	Mønster Dybde	Felg
OBP04201109	20x11-9	6	43F	12mm	9"
OBP04221109	22x11-9	6	48F	12mm	9"



obor **ADVENT MX** WP05 / WP06

OBOR Advent MX; dekk med kraftig mønster for ATV motorcross løpskjøring. Supert grep fra både løst til hardpakket underlag. Dekkets stabilitet tillater presise hopp, og ikke minst presise landinger.



TOPP SELGER!

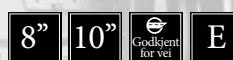

Varenummer	Dimensjoner	PR	Li/SI	Mønster Dybde	Felg
OBP05190610	19x6-10	4	14F	10mm	5"
OBP05200610	20x6-10	4	17F	12mm	5"

Varenummer	Dimensjoner	PR	Li/SI	Mønster Dybde	Felg
OBP06181008	18x10-8	4	29F	12mm	8"



obor
Advent MX

ATV DEKK

GALLERI OBOR



obor CORNELIUS WU11/ WU12

Det perfekte dekket for ATV og SxS. Cornelius har et unikt mønster som gir meget bra grep på alle underlag. Ekstremt godt grep grus. Radial 6 eller 8 lags stamme. Unik gummiblanding i sidevegger for å motså punkteringer.



TOPP SELGER! 12" 14"

Varenummer	Dimensjoner	PR	Li/SI	Mønster Dybde	Felg
OBU11250812	25x8R12	6	68F	20 mm	6"
OBU11260912	26x9R12	6	71F	20 mm	7"
OBU11260914	26x9R14	6	70F	20 mm	7"
OBU11270914	27x9R14	6	73F	20 mm	7"
OBU12281014	28x10R14	8	82F	20 mm	8"
OBU11290914	29x9R14	8	81F	20 mm	7"

Varenummer	Dimensjoner	PR	Li/SI	Mønster Dybde	Felg
OBU12251012	25x10R12	6	72F	20 mm	7,5"
OBU12261212	26x12R12	6	78F	20 mm	9"
OBU12261114	26x11R14	6	77F	20 mm	8"
OBU12271114	27x11R14	6	79F	20 mm	8"
OBU12281014	28x10R14	8	82F	20 mm	8"
OBU12291114	29x11R14	8	87F	20 mm	8"



obor CYPRESS P3058 / P3059

OBOR Cypress; slitesterk gummiblanding for lang levetid. Med mønster som vil øke knastenes styrke og garantere kjørekomfort. Aggressivt skuldermønster utvidet til sidevegg som vil forbedre dekkens punkteringsmotstand og beskytte felgene.



12" 14"

Varenummer	Dimensjoner	PR	Li/SI	Mønster Dybde	Felg
OB058250812	25x8-12	6	68F	18 mm	6"
OB058260812	26x8-12	6	71F	18 mm	6"
OB058270914	27x9R14	6	74F	18 mm	7"

Varenummer	Dimensjoner	PR	Li/SI	Mønster Dybde	Felg
OB059251012	25x10-12	6	74F	18 mm	7,5"
OB059261012	26x10-12	6	76F	18 mm	7,5"
OB059271114	27x11R14	6	81F	18 mm	8"



obor RIPLE WU13 / WU14

Lett vekt 6-lags radial stamme gir rask akselerasjon. OBOR Riple har retningsbestemt mønster som gir behagelig kjøreopplevelse.



12" 14"

Varenummer	Dimensjoner	PR	Li/SI	Mønster Dybde	Felg
OB13250812	25x8R12	6	68F	22 mm	6"
OB13260912	26x9R12	6	74F	22 mm	7"
OB13270914	27x9R14	6	75F	26 mm	7"

Varenummer	Dimensjoner	PR	Li/SI	Mønster Dybde	Felg
OB14251012	25x10R12	6	75F	22 mm	7,5"
OB14261112	26x11R12	6	80F	22 mm	8"
OB14271114	27x11R14	6	81F	26 mm	8"



obor **HOWLER** WU19/WU20

Dekkene er primært ment for ekstrem off road kjøring, og er dermed ikke E-merket og godkjent for vei. Flere dimensjoner kommer fortløpende



NYHET!

14"

Varenummer	Dimensjoner	PR	Li/SI	Mønster Dybde	Felg
OBU19270914	27X9R14	6			7"

Varenummer	Dimensjoner	PR	Li/SI	Mønster Dybde	Felg
OBU20271114	27X11R14	6			8"



obor **CRAWLER** P3057

"Light Truck - Off Road" inspirert dekk med supert grep på hardt underlag. Alle dimensjoner vil etter hvert få både M+S og E-merking.



BEST SELGER!

12"

14"

15"



E

Varenummer	Dimensjoner	PR	Li/SI	Mønster Dybde	Felg
OB057250812	25x8R12	8	68M	15 mm	6,5"
OB057260814	26x8R14	6	54M	15 mm	6,5"
OB057260914	26x9R14	6	73M	15 mm	7"
OB057270914	27x9R14	6	54M	15 mm	7"
OB057260915	26x9R15	8	73M	15 mm	7"

Varenummer	Dimensjoner	PR	Li/SI	Mønster Dybde	Felg
OB057251012	25x10R14	8	73M	15 mm	8"
OB057261014	26x10R14	6	61M	15 mm	8"
OB057261114	26x11R14	8	78M	15 mm	8"
OB057271114	27x11R14	6	60M	15 mm	8"
OB057261115	26x11R15	8	78M	15 mm	8"
OB057281014	28x10R14	8	59M	15 mm	8"
OB057301014	30x10R14	8	63M	15 mm	8"
OB057281015	28x10R15	8	59M	15 mm	8"
OB057301015	30x10R15	8	63M	15 mm	8"
OB057311015	31x10R15	8	80M	15 mm	8"
OB057321015	32x10R15	8	66M	15 mm	8"



obor
Crawler

ATV DEKK

GALLERI OBOR



obor BRAWLER WL05

Nytt SxS DOT-dekk. Med 10-lags radial stamme og en spesialisert gummiforbindelse som gir utmerket ytelse i alle terreng. Flatere mønsterdesign gir utmerket trekraft og slitestyrke. Unike og aggressive sideveggmønster gir utmerket punkteringsmotstand og fantastisk utseende.



14"

Varenummer	Dimensjoner	PR	Li/SI	Mønster Dybde	Felg
OBL05281014	28x10R14	10	58M	13 mm	8"
OBL05301014	30x10R14	10	62M	13 mm	8"
OBL05321014	32x10R14	10	66M	13 mm	8"



obor ANTELOPE WL03

UTV 8-lags radialdekk, motstandsdyktig mot punkteringer. "Light truck"-mønster for alle underlag.



12" 14" 15"

Varenummer	Dimensjoner	PR	Li/SI	Mønster Dybde	Felg
OBL03260912	26x9R12	6	53M	13 mm	7"

Varenummer	Dimensjoner	PR	Li/SI	Mønster Dybde	Felg
OBL03261112	26x11R12	6	60M	13 mm	8"
OBL03281014	28x10R14	8	59M	15 mm	7"
OBL03301014	30x10R14	8	63M	15 mm	7"
OBL03281015	28x10R15	8	58M	15 mm	7"
OBL03301015	30x10R15	8	63M	15 mm	7"
OBL03321015	32x10R15	8	66M	15 mm	7"



obor MUDSLING WU05 / WU06

"Mud lite" - dekket som er effektivt til trial, lett gjørme, men også steinete og hardt underlag. Dekkene har veldig bra gripeevne i de nevnte terreng. Har allerede rukket til å bli en av våre bestselgere.



BEST SELGER! 12" 14"

Varenummer	Dimensjoner	PR	Li/SI	Mønster Dybde	Felg
OBU05240812	24x8-12	8	55J	18 mm	6"
OBU05250812	25x8-12	8	63J	20 mm	6"
OBU05260812	26x8R12	6	63J	19 mm	6"
OBU05260914	26x9-14	6	65J	19 mm	7"

Varenummer	Dimensjoner	PR	Li/SI	Mønster Dybde	Felg
OBU06241012	24x10-12	8	62J	18mm	7"
OBU06251012	25x10-12	8	69J	20 mm	8"
OBU06261012	26x10R12	6	69J	20 mm	8"
OBU06261114	26x11-14	6	74J	20 mm	8"



obor **SCORPIO** WU03 / WU04

Mud dekk med unikt mønster for virkelig å kjøre i "MUD TERRAIN." Scorpio dekkene er testet med enestående grep på gjørmete underlag. "Best choice" for deg som kjører mye i myr og gjørmete terreng.











**BEST
SELGER!**

12" 14"

Varenummer	Dimensjoner	PR	Li/SI	Mønster Dybde	Felg
OBU03250812	25x8-12	6	52J	30 mm	6"
OBU03250912	26x9-12	6	58J	30 mm	7"
OBU03260914	26x9-14	6	56J	30 mm	7"
OBU03270914	27x9-14	6	59J	38 mm	7"

Varenummer	Dimensjoner	PR	Li/SI	Mønster Dybde	Felg
OBU04251012	25x10-12	6	59J	30 mm	8"
OBU04261112	26x11-12	6	64J	30 mm	8"
OBU04261212	26x12-12	6	67J	30 mm	8"
OBU04261114	26x11-14	6	63J	30 mm	8"
OBU04271114	27x11-14	6	65J	38 mm	8"



WANDA TERRENG GUIDE							
							
		STEIN	HARDT UNDERLAG	INTERMEDIATE	LØS LEIRJORD	SAND	GJØRME
ATV UTILITY	P3006						
	P350						
	P373(A)						
	P375						
	P3035						
	VS3020 						
	P306 A/T Master						
	YG3266 KUBOTA RTV						
	P827						
	P349						
	P354						
ATV SPORT	P3018						
	P329						
	P308						
	P348						
	P336						





WANDA P3006

Halvgrovt "all round" dekk til de fleste ATV/UTV. Kraftige skulderribber for å beskytte sideveggene, samt ekstra trekk kraft. 19mm mønsterdybde. Dekket er E-merket og godkjent for gatebruk. J-merket for 100 km/t.



**TOPP
SELGER!**

12"

14"



E

Varenummer	Dimensjoner	PR	Li/SI	Mønster Dybde	Felg
WD300625812	25x8-12	6	43J	19 mm	6,5"
WD300626912	26x9-12	6	49J	19 mm	7"
WD300627912	27x9-12	6	69J	19 mm	7"
WD300626914	26x9-14	6	49J	19 mm	7"
WD300627914	27x9-14	6	67J	19 mm	7"

Varenummer	Dimensjoner	PR	Li/SI	Mønster Dybde	Felg
WD3006251012	25x10-12	6	50J	19 mm	8"
WD3006261112	26x11-12	6	55J	19 mm	9"
WD3006271112	27x11-12	6	76J	19 mm	9"
WD3006261114	26x11-14	6	56J	19 mm	9"
WD3006271114	27x11-14	6	74J	19 mm	9"



WANDA P350

Grovt off road dekk til de fleste 4x4. Kraftige skulderribber for å beskytte sideveggene, samt ekstra trekk kraft. 20mm mønsterdybde. Dekket er e-merket og godkjent for gatebruk. Vi anbefaler dette dekket til de som kjører aller mest off road, og ikke så mye på vei.



**TOPP
SELGER!**

12"

14"



E

Varenummer	Dimensjoner	PR	Li/SI	Mønster Dybde	Felg
WD35025812	25x8-12	6	43J	20 mm	6,5"
WD35026912	26x9-12	6	49J	20 mm	7"
WD35027914	27x9-14	6	49J	20 mm	7"
WD350271014	27x10-14	6	70J	20 mm	7,5"

Varenummer	Dimensjoner	PR	Li/SI	Mønster Dybde	Felg
WD350251012	25x10-12	6	50J	20 mm	8"
WD350261212	26x12-12	6	58J	20 mm	9,5"
WD350271214	27x12-14	6	70J	20 mm	9,5"



P373

P373A



**BEST
SELGER!**

12"

14"



E

WANDA P373 / P373A

Retningsbestemt mønster med lettvektsgdesign for kraftig akselasjon og bremsing. 25" dekkene er E-merket og godkjent for gatebruk. Disse er også J-merket for 100 km/t. Kun dekkene som er med 14" felgdiameter er radialdekk. Dekkene kan pigges

Varenummer	Dimensjoner	PR	Li/SI	Mønster Dybde	Felg
WD37325812	25x8-12	6	43J	15,2 mm	6,5"
WD37326812	*26x8-12	6		16 mm	6,5"
WD37326814	*26x8R14	6		16 mm	6,5"

* Ikke E-merket

Varenummer	Dimensjoner	PR	Li/SI	Mønster Dybde	Felg
WD373251012	25x10-12	6	50J	15,2 mm	8"
WD373A251112	**25x11-12	6	80F	16 mm	8"
WD373261012	*26x10-12	6		16 mm	8"
WD373261014	*26x10R14	6		16 mm	8"

** Mønster P373A

ATV DEKK GALLERI WANDA



WANDA P375

Et av våre groveste ATV dekk til de største arbeidsmaskinene. Rå fremkommelighet. Dekkene er E-merket, men anbefales ikke til gatebruk.



**TOPP
SELGER!**

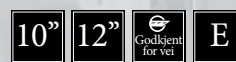

Varenummer	Dimensjoner	PR	Li/SI	Mønster Dybde	Felg
	25x8-12	6	43J	26,2 mm	6,5"
	26x9-12	6	49J	27,8 mm	7"
	27x9-12	6	52J	27,8 mm	7"

Varenummer	Dimensjoner	PR	Li/SI	Mønster Dybde	Felg
	25x11-10	6	53J	27,8 mm	8"
	25x10-12	6	50J	26,2 mm	8"
	26x12-12	6	58J	27,8 mm	9,5"
	27x12-12	6	60J	27,8 mm	9,5"



WANDA P3035

Retningsbestemt mønster. Tett mønster for godt grep på hardt underlag. Dekkene er E-merket og godkjent for gatebruk. J-merket for 100 km/t. Vi anbefaler dette dekket til de som ønsker et allround dekk til varierende underlag. Kan pigges.



**BEST
SELGER!**



Varenummer	Dimensjoner	PR	Li/SI	Mønster Dybde	Felg
	25x8R12	6	60J	16,2 mm	6,5"
	26x9R12	6	66J	16,2 mm	7"
	26x9R14	6	65J	16,2 mm	7"

Varenummer	Dimensjoner	PR	Li/SI	Mønster Dybde	Felg
	25x10R12	6	67J	16,2 mm	8"
	26x11R12	6	72J	16,2 mm	9"
	26x11R14	6	72J	16,2 mm	9"



WANDA VS3020

Ikke retningsbestemt mønster. Store knaster for perfekt grep på hardt underlag. Skulder ribber for å beskytte felger, samt dekk sider i røfft terreng. Dekkene er E-merket og godkjent for gatebruk. J hastighetsmerking for 100 km/t. Kan pigges. Abefales kun til de største ATV og UTV, da dekkene er tunge og kraftige. Alle er M+S merket utenom 28x10R14

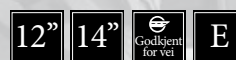

Varenummer	Dimensjoner	PR	Li/SI	Mønster Dybde	Felg
	26x9R12	6	65M	17 mm	7"
	27x9R12	6	67M	17 mm	7"
	26x9R14	8	67M	17 mm	7"
	27x9R14	8	70M	17 mm	7"

Varenummer	Dimensjoner	PR	Li/SI	Mønster Dybde	Felg
	26x11R12	6	71M	17 mm	8"
	27x11R12	6	75M	17 mm	8"
	26x11R14	8	76M	17 mm	8"
	27x11R14	8	78M	17 mm	8"
	28x10R14	8	77J	17 mm	8"



WANDA P306

A/ T Master. Retningsbestemt mønster. Aggressivt mønster for godt grep. Dekkene er E-merket og godkjent for gatebruk. J-merket for 100 km/t.



Varenummer	Dimensjoner	PR	Li/SI	Mønster Dybde	Felg
WD22810P306A	22x8-10	6	38J	15,5 mm	6,5"
WD221110P306	22x11-10	6	47J	19,5 mm	9"
WD3062411104	24x11-10	4	47J	19,5 mm	9"
WD24812P306	24x8-12	4	35J	15,5 mm	6,5"



WANDA YG3266

Spesialdekk til Kubota RTV-serie. Bergnet for meget høy laste evne. Hele 615 kg ved 40 km/t. Dekkene er E-merket og godkjent for gatebruk. Anbefalt lufttrykk 25 psi.



Varenummer	Dimensjoner	PR	Li/SI	Mønster Dybde	Felg
WD2510123266	25x10-12	6	91A8	17 mm	8,5"



WANDA P827

Ikke retningsbestemt "gatedekk". Dekkene er E-merket og godkjent for gatebruk. K-merket for 110 km/t.



Varenummer	Dimensjoner	PR	Li/SI	Mønster Dybde	Felg
WD200812	20x8-12	4	42K	7 mm	6,5"
WD201012	20-10-12	4	45K	8 mm	8"



WANDA P349

Retningsbestemt mønster med lettvektsdesign for kraftig akselrasjon og bremsing på hardt underlag. Typisk veimønster for behagelig kjøring. E-merket. N hastighetsmerking for 140 km/t.



Varenummer	Dimensjoner	PR	Li/SI	Mønster Dybde	Felg
WD349221010	22x10-10	4	39N	8 mm	8"
WD34926814	26x8-14	6	74N	10 mm	6,5"
WD349261014	26x10-14	6	81N	10 mm	8"



WANDA P354

Retningsbestemt mønster med lettvektsdesign for kraftig akselrasjon og bremsing på hardt underlag. Typisk veimønster for behagelig kjøring. E-merket.

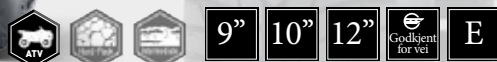

Varenummer	Dimensjoner	PR	Li/SI	Mønster Dybde	Felg
WD35420109	20x10-9	4	34N	8 mm	8"
WD35421710	21x7-10	4	25N	8 mm	5,5"
WD35425812	25x8-12	4	70F	8 mm	6,5"
WD354251012	25x10-12	4	70F	8 mm	8"



WANDA P3018

Ikke retningsbestemt mønster. Perfekt for veikjøring til små 2x4. E-merket. J-merket for 100 km/t, eller F-merket for 80 km/t. Kan pigges..



Varenummer	Dimensjoner	PR	Li/SI	Mønster Dybde	Felg
WD301821710	21x7-10	4	58J	11 mm	5,5"
WD301822710	22x7-10	4	28F	11 mm	5,5"
WD3018221010	22x10-10	4	39J	12,5 mm	8"

ATV DEKK

GALLERI WANDA



WANDA P329

Retningsbestemt mønster med skråstilte ribber for mykt/middels underlag. E-merket og godkjent for vei. Gode selvrensingsegenskaper. F hastighetsmerking for 80 km/t.



Varenummer	Dimensjoner	PR	Li/SI	Mønster Dybde	Felg
WD3291687	16x8-7	4	20F	12 mm	6,5"



WANDA P308

Perfekt dekk til ATV hengere og utstyr. Dekket er oppgitt til å tåle 179 kg v/7 psi. Gode selvrensingsegenskaper.



Varenummer	Dimensjoner	PR	Li/SI	Mønster Dybde	Felg
WD22118P308	22x11-8	6		16 mm	9"



WANDA P348

Retningsbestemt mønster. Aggressivt mønster for godt grep. Dekkene er E-merket og godkjent for gatebruk. J-merket for 100 km/t.



Varenummer	Dimensjoner	PR	Li/SI	Mønster Dybde	Felg
	23x7-10	4	31J	15 mm	5,5"



WANDA P336

Kraftig dekk for den kresne. Grovt, selvrensende mønster. Kan brukes til løpskjøring. J-merket for 100 km/t.



Varenummer	Dimensjoner	PR	Li/SI	Mønster Dybde	Felg
	20x11-8	4	34J	12 mm	9"



WANDA P311

Retningsbestemt mønster for små 2x4 ATV. Lettvektsdesign for kraftigere akselerasjon og bremsing. Åpent mønster for god selvrensing. E-merket ATV dekk som er godkjent for vei. J-merket for 100 km/t. Utmerket for pigging



Varenummer	Dimensjoner	PR	Li/SI	Mønster Dybde	Felg
	18x9,5-8	4	33J	15 mm	7"
	19x7-8	4	28F	15 mm	5,5"
	19x9,5-8	4	36J	15 mm	7"
	21x7-8	4	25J	15 mm	5,5"



WANDA P322

Ikke retningsbestemt mønster. Grovt knastmønster for perfekt grep på varierende underlag. 22x11-8 dekket er E-merket og godkjent for gatebruk. J hastighetsmerking for 100 km/t..N



Varenummer	Dimensjoner	PR	Li/SI	Mønster Dybde	Felg
	*20x7-8	4		7 mm	5,5"
	22x11-8	4	43J	14 mm	9"

* Ikke Emerket



WANDA P342

Ikke retningsbestemt mønster. Perfekt for veikjøring til små 2x4. E-merket. J-merket for 100 km/t, eller J-merket for 100 km/t. Kan pigges.



9" Godkjent for vei E

Varenummer	Dimensjoner	PR	Li/SI	Mønster Dybde	Felg
	20x10-9	4	34J	13,5 mm	8"



WANDA P826

Retningsbestemt mønster med skråstilte ribber for hardt underlag. Ikke E-merket. K hastighetsmerking for 110 km/t.



10"

Varenummer	Dimensjoner	PR	Li/SI	Mønster Dybde	Felg
	205/50-10	4	49K	5,5 mm	6,5"
	225/45-10	4	50K	6 mm	7"



WANDA P330

Retningsbestemt mønster. Grovt knastmønster for perfekt grep på varierende underlag. E-merket og godkjent for gattebruk. F hastighetsmerking for 80 km/t.



6"

Varenummer	Dimensjoner	PR	Li/SI	Mønster Dybde	Felg
	145/70-6	2	18F	6 mm	5"



WANDA P361

Retningsbestemt mønster. Grovt knastmønster for perfekt grep på varierende underlag. E-merket og godkjent for gattebruk. F hastighetsmerking for 80 km/t.



6"

Varenummer	Dimensjoner	PR	Li/SI	Mønster Dybde	Felg
	145/70-6	4	18F	6 mm	5"



WANDA TYRE
P373 | P373A

ATV DEKK GALLERI MAXXIS



MAXXIS[®] BIG HORN 2.0 MU-09 / MU-10

Det perfekte dekket for ATV og UTV. Veldig bra allround dekk. Radial stamme. Fungerer veldig bra på alle underlag.

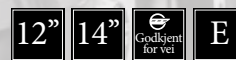

Varenummer	Dimensjoner	PR	Li/SI	Mønster Dybde	Felg
MX52598400	25x8R12	6	43N		6"
MX52599290	26x9R12	6	49N		7"
MX52599866	26x9R14	6	48N		7"
MX52599897	27x9R14	4	54K		7"

Varenummer	Dimensjoner	PR	Li/SI	Mønster Dybde	Felg
MX52598750	25x10R12	6	50N		8"
MX52599319	26x11R12	6	55N		8"
MX52599895	26x11R14	6	56N		8"
MX52599900	27x11R14	4	73K		8"



MAXXIS[®] CEROS MU-07 / MU-18

Meget bra veidekk til ATV og UTV. Lang kjørelengde. Radial stamme. Fungerer best på hardt underlag, men kan også brukes til noe offroad kjøring.

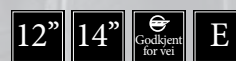

Varenummer	Dimensjoner	PR	Li/SI	Mønster Dybde	Felg
MX52598390	25x8R12	6	68N		6"
MX52599285	26x9R12		74N		7"
MX52599863	26x9R14		73N		7"
MX52599889	27x9R14	6	50M		7"
MX52599925	29x9R14	6	55M		7"

Varenummer	Dimensjoner	PR	Li/SI	Mønster Dybde	Felg
MX52598745	25x10R12	6	74N		8"
MX52599317	26x11R12		79N		8"
MX52599890	26x11R14		78N		8"
MX52599924	27x11R14	6	57M		8"
MX52599926	29x11R14	6	61M		8"



MAXXIS[®] ZILLA MU-01 / MU-02

Mud dekk med utmerket trekk kraft og meget bra kjøre egenskaper. Dekkene anbefales til de som kjører mest offroad, selv om de fleste dimensjonene er E-merket og godkjent for vei.

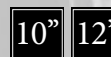

Varenummer	Dimensjoner	PR	Li/SI	Mønster Dybde	Felg
MX52598375	25x8-12	6	43J		6"

Varenummer	Dimensjoner	PR	Li/SI	Mønster Dybde	Felg
MX52501809	25x11-10	6			9"



MAXXIS **STREETMAXX** C9272 / C9273

Typisk veidekk fra Maxxis. Lang levetid. Fungerer meget bra på også vår vei.
E-merket og godkjent for vei.



Varenummer	Dimensjoner	PR	Li/SI	Mønster Dybde	Felg
MX52598365	25x8-12	40N			6"

Varenummer	Dimensjoner	PR	Li/SI	Mønster Dybde	Felg
MX52598725	25x10-12	40N			8"



MAXXIS **CARNIVORE** ML1

Ultimat kontroll offroad. Spesiell gummiblanding, for å sikre jevn slitasje på slitebanen.
Utmerket trekk krasft på steiner, røtter og sand.
E-merket og godkjent for vei.



Varenummer	Dimensjoner	PR	Li/SI	Mønster Dybde	Felg
MX52610604	30x10R14	8	60M		8"



ATV DEKK GALLERI DURO



DURO KADEN DI-2036

Velkjent dekk fra Duro. Kan brukes på de alle fleste underlag. Radial stamme. Originalmonteres på blant annet Arctic Cat.

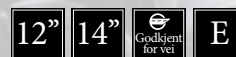

Varenummer	Dimensjoner	PR	Li/SI	Mønster Dybde	Felg
DU29015	25x8R12	6	45J	13,5 mm	6"
DU29020	26x9R14	4	61K	16,5 mm	7"

Varenummer	Dimensjoner	PR	Li/SI	Mønster Dybde	Felg
DU29016	25x10R12	6	52J	13,5 mm	8"
DU29019	26x11R14	4	81K	16,5 mm	8"



DURO RED EAGLE DI-2013

Retningsbestemt mønster med lettvektsdesign for kraftig akselasjon og bremsing. Dekkene er E-merket og godkjent for gatebruk.



Varenummer	Dimensjoner	PR	Li/SI	Mønster Dybde	Felg
DU2682	25x8-12	4	38J	13,5 mm	6"

Varenummer	Dimensjoner	PR	Li/SI	Mønster Dybde	Felg
DU29516	25x10-12	4	45J	13,5 mm	8"
DU29451	25x11-12	4	48F	13,5 mm	8"



DURO BUFFALO DI-2010

6 lags stamme. Unik gummiblanding i sidevegger for å motså punkteringer. Gode flyteevner og ekstremt grep.



Varenummer	Dimensjoner	PR	Li/SI	Mønster Dybde	Felg
DU281012	28x10-12	6	57N	31 mm	7"

Varenummer	Dimensjoner	PR	Li/SI	Mønster Dybde	Felg
DU281212	28x12-12	6	62N	31 mm	8"



DURO TOP FIGHTER DI-2014
Store mønsterblokker for større kontaktflete. Perfekt for asfalt.



Varenummer	Dimensjoner	PR	Li/SI	Mønster Dybde	Felg
DU25812-2014	25x8-12	6	43N	10 mm	6"

Varenummer	Dimensjoner	PR	Li/SI	Mønster Dybde	Felg
DU251012-2014	25x10-12	6	50N	10 mm	8"



POWER TRAIL DI-2009
Perfekt dekk både til løpskjøring og hob-
bykjøring. E-merket og godkjent for vei.



Varenummer	Dimensjoner	PR	Li/SI	Mønster Dybde	Felg
DU2667	19x9,5-9	2	21J	11 mm	8"



DURO HF-247
Et av våre mestselgende dekk til små
ATV for veikjøring.



Varenummer	Dimensjoner	PR	Li/SI	Mønster Dybde	Felg
DU1877-247	18x7-7	2	10F	10 mm	5,5"
DU18958-247	18x9,5-8	2	20F	10 mm	7"
DU1978-247	19x7-8	2	10J	10 mm	5,5"
DU21710-247	21x7-10	4	25N	12 mm	5,5"
DU22710-247	22x7-10	4	28N	10 mm	5,5"
DU221010-247	22x10-10	4	39N	10 mm	8"



TRASHER HF-277
Front dekk fra røft til løst terreng.



Varenummer	Dimensjoner	PR	Li/SI	Mønster Dybde	Felg
DU1978-277	19x7R8	2	13F	9 mm	5,5"



BLACK HAWK DI-2003
Retningsbestemt mønster med lettvekts-
design for kraftig akselrasjon og
bremsing. Dekkene er E-merket og
godkjent for gatebruk.



Varenummer	Dimensjoner	PR	Li/SI	Mønster Dybde	Felg
DU1687-2003	16x8-7	6	19J	10 mm	5,5"

ATV FELGER

URA RAPTOR

URA Raptor er designet i Norge og produsert i Asia, hos en av verdens største felgfabrikker. Felgfabrikken produserer i dag en rekke kjente merker for flere anerkjente Europeiske felgprodusenter, der alle har strenge krav til kvalitet.

URA Raptor; produsert for å dekke de aller mest solgte ATV og UTV. Produseres i Matt Gun Metal med ulike bredder foran og bak i 12" og 14".



URA RAPTOR - MATT GUN METAL

Varenummer	Størrelse	Boltsirkel	ET	Navnhull	Vekt netto	Max Load
URR127110	7x12	4x110	2,5	86 mm	4,8	400 kg
URR128110	8x12	4x110	-10,2	86 mm	5,1	400 kg
URR127115	7x12	4x115	2,5	80 mm	4,8	400 kg
URR128115	8x12	4x115	-10,2	80 mm	5,1	400 kg
URR127136	7x12	4x136	2,5	110,5 mm	4,8	400 kg
URR128136	8x12	4x136	-10,2	110,5 mm	5,1	400 kg
URR127156	7x12	4x156	2,5	131,1 mm	4,8	400 kg
URR128126	8x12	4x156	-10,2	131,1 mm	5,1	400 kg
URR147110	7x14	4x110	2,5	86 mm	5,3	400 kg
URR148110	8x14	4x110	-10,2	86 mm	6,8	400 kg
URR147115	7x14	4x115	2,5	80 mm	5,3	400 kg
URR148115	8x14	4x115	-10,2	80 mm	6,8	400 kg
URR147136	7x14	4x136	2,5	110,5 mm	5,3	400 kg
URR148136	8x14	4x136	-10,2	110,5 mm	6,8	400 kg
URR147156	7x14	4x156	2,5	131,1 mm	5,3	400 kg
URR148156	8x14	4x156	-10,2	131,1 mm	6,8	400 kg



URA SPLINES MUTTERE

Varenummer	Type	Farge
UR10125	M10x1,25 Mutter	Sort
UR00038	3/8" Mutter	Sort
UR12125	M12x1,25 Mutter	Sort
UR12150	M12x1,50 Mutter	Sort
UR70007	Splines Verktøy	Sort

OBS!
URA SPLINES MUTTERE
MÅ BENYTTES PÅ
URA RAPTOR



Varenummer	Type	Farge
URMG-P1789GMX	Senterkopp Raptor	Gun Metal
URMG-P1789BX	Senterkopp Raptor	Matt Black



ATV FELGER

URA RAPTOR

Alle Polaris ATV bruker 3/8UNF muttere, mens XP bruker 10x1,25. OBS! Ranger og RZR bruker 3/8UNF eller 12x1,50. Nesten alle andre merker/modeller bruker 10x1,25.

OBS! De fleste av Japanske modeller med stiv bakaksel bruker lavere innpress enn ET-10. Her må spacere eller andre felger benyttes. Alle felger med "backspace 4 tommer (10cm)", noe som betyr at de aller fleste ATV og UTV vil bli bredere.

Matt Black Polished leveres i 14" til de aller fleste ATV/UTV. Nyhet 2021 Matt Black Blue/Red Transparent Lip i 7 og 8x14"; 4x136 og 4x156.



URA RAPTOR - MATT BLACK POLISHED

Varenummer	Størrelse	Boltsirkel	ET	Navhull	Vekt netto	Max Load
URR147110BP	7x14	4x110	2,5	86 mm	5,3	400 kg
URR148110BP	8x14	4x110	-10,2	86 mm	6,8	400 kg
URR147136BP	7x14	4x136	2,5	110,5 mm	5,3	400 kg
URR148136BP	8x14	4x136	-10,2	110,5 mm	6,8	400 kg
URR147156BP	7x14	4x156	2,5	131,1 mm	5,3	400 kg
URR148156BP	8x14	4x156	-10,2	131,1 mm	6,8	400 kg

MATT BLACK RED LIP

Varenummer	Størrelse	Boltsirkel	ET	Navhull	Vekt netto	Max Load
URR147136BR	7x14	4x136	2,5	110,5 mm	5,3	400 kg
URR148136BR	8x14	4x136	-10,2	110,5 mm	6,8	400 kg
URR147156BR	7x14	4x156	2,5	131,1 mm	5,3	400 kg
URR148156BR	8x14	4x156	-10,2	131,1 mm	6,8	400 kg

RAPTOR
URA

MATT BLACK BLUE LIP

Varenummer	Størrelse	Boltsirkel	ET	Navhull	Vekt netto	Max Load
URR147136BB	7x14	4x136	2,5	110,5 mm	5,3	400 kg
URR148136BB	8x14	4x136	-10,2	110,5 mm	6,8	400 kg
URR147156BB	7x14	4x156	2,5	131,1 mm	5,3	400 kg
URR148156BB	8x14	4x156	-10,2	131,1 mm	6,8	400 kg



@urawheels



Artic Cat			BOLT SIRKEL	OFFSET	ET	VARE# FELG	MUTTER STINGNING	VARE# MUTTER
Arctic Cat 250/300 2x4/4x4 '98-02A 300i	Front	12X7	4x115	4+3	ET2.5	UR127115	10x1,25	UR10125
	Rear	12X8	4x115	4+4	ET-10	UR128115	10x1,25	UR10125
Arctic Cat 400i/500i/650i/700i/1000 2x4/4x4 '02-11A TRV400/ 550/700/1000 2010-11A	Front	12x7	4x115	4+3	ET2.5	UR127115	10x1,25	UR10125
	Bak	12x8	4x115	4+4	ET-10	UR128115	10x1,25	UR10125
	Front	14X7	4x115	4+3	ET2.5	UR147115	10x1,25	UR10125
	Bak	14X8	4x115	4+4	ET-10	UR148115	10x1,25	UR10125
Arctic Cat Prowler 06-011A	Front	14X7	4x115	4+3	ET2.5	UR147115	10x1,25	UR10125
	Bak	14X8	4x115	4+4	ET-10	UR148115	10x1,25	UR10125

CAN-AM

OUTLANDER 330/400/500/570/650/800/850/1000 03-	Front	12X7	4x136	4+3	ET2.5	UR127136	10x1,25	UR10125
	Rear	12X8	4x136	4+4	ET-10	UR128136	10x1,25	UR10125
	Front	14X7	4x136	4+3	ET2.5	UR147136	10x1,25	UR10125
	Rear	14X8	4x136	4+4	ET-10	UR148136	10x1,25	UR10125
RENEGADE 500/570/800/850/1000 09-	Front	12X7	4x136	4+3	ET2.5	UR127136	10x1,25	UR10125
	Rear	12X8	4x136	4+4	ET-10	UR128136	10x1,25	UR10125
	Front	14X7	4x136	4+3	ET2.5	UR147136	10x1,25	UR10125
	Rear	14X8	4x136	4+4	ET-10	UR148136	10x1,25	UR10125
TRAXTER 500 4X4 99-06	Front	12X7	4x110	4+3	ET2.5	UR127110	10x1,25	UR10125
	Rear	12X8	4x110	2+6	ET-10**	UR148110**	10x1,25	UR10125
QUEST 650 01-06	Front	12X7	4x110	4+3	ET2.5	UR127110	10x1,25	UR10125
	Rear	12X8	4x110	2+6	ET-10**	UR148110**	10x1,25	UR10125
COMMANDER 800/1000 13-	Front	12X7	4x136	4+3	ET2.5	UR127136	10x1,25	UR10125
	Rear	12X8	4x136	4+4	ET-10	UR128136	10x1,25	UR10125
	Front	14X7	4x136	4+3	ET2.5	UR147136	10x1,25	UR10125
	Rear	14X8	4x136	4+4	ET-10	UR148136	10x1,25	UR10125
MAVERICK/MAX 1000 14-	Front	12X7	4x136	4+3	ET2.5	UR127136	10x1,25	UR10125
	Rear	12X8	4x136	4+4	ET-10	UR128136	10x1,25	UR10125
	Front	14X7	4x136	4+3	ET2.5	UR147136	10x1,25	UR10125
	Rear	14X8	4x136	4+4	ET-10	UR148136	10x1,25	UR10125
DEFENDER 16-	Front	12X7	4x136	4+3	ET2.5	UR127136	10x1,25	UR10125
	Rear	12X8	4x136	4+4	ET-10	UR128136	10x1,25	UR10125
	Front	14X7	4x136	4+3	ET2.5	UR147136	10x1,25	UR10125
	Rear	14X8	4x136	4+4	ET-10	UR148136	10x1,25	UR10125

HONDA

TRX250 RECON 08-16	Front	12X7	4x110	4+3	ET2.5	UR127110	10x1,25	UR10125
	Rear	12X8	4x110	2+6	ET-10**	UR148110**	10x1,25	UR10125
TRX300 FOURTRAX 4X4 89-00	Front	12X7	4x110	4+3	ET2.5	UR127110	10x1,25	UR10125
	Rear	12X8	4x110	2+6	ET-10**	UR148110**	10x1,25	UR10125
TRX350 RANCHER S-ES 4X4 00-06	Front	12X7	4x110	4+3	ET2.5	UR127110	10x1,25	UR10125
	Rear	12X8	4x110	2+6	ET-10**	UR148110**	10x1,25	UR10125
TRX400/420 RANCHER 4X4 04-14	Front	12X7	4x110	4+3	ET2.5	UR127110	10x1,25	UR10125
	Rear	12X8	4x110	2+6	ET-10**	UR148110**	10x1,25	UR10125
TRX400 FOREMAN 4X4 96-06	Front	12X7	4x110	4+3	ET2.5	UR127110	10x1,25	UR10125
	Rear	12X8	4x110	2+6	ET-10**	UR148110**	10x1,25	UR10125
TRX420AT/500AT RANCHER 09-17 (IRS)	Front	12X7	4x110	4+3	ET2.5	UR127110	10x1,25	UR10125
	Rear	12X8	4x110	4+4	ET-10	UR128110	10x1,25	UR10125
	Front	14X7	4x110	4+3	ET2.5	UR147110	10x1,25	UR10125
	Rear	14X8	4x110	4+4	ET-10	UR148110	10x1,25	UR10125
TRX450/500 FOREMAN S-ES 4X4 98-14	Front	12X7	4x110	4+3	ET2.5	UR127110	10x1,25	UR10125
	Rear	12X8	4x110	2+6	ET-10**	UR148110**	10x1,25	UR10125
TRX500 RUBICON 4X4 01-11	Front	12X7	4x110	4+3	ET2.5	UR127110	10x1,25	UR10125
	Rear	12X8	4x110	2+6	ET-10**	UR148110**	10x1,25	UR10125
TRX650/680 RINCON 4X4 02-17 (IRS)	Front	12X7	4x110	4+3	ET2.5	UR127110	10x1,25	UR10125
	Rear	12X8	4x110	4+4	ET-10	UR128110	10x1,25	UR10125
	Front	14X7	4x110	4+3	ET2.5	UR147110	10x1,25	UR10125
	Rear	14X8	4x110	4+4	ET-10	UR148110	10x1,25	UR10125
BIG RED 700 MUV 09-13	Front	12X7	4x110	4+3	ET2.5	UR127110	12x1,50	UR12150
	Rear	12X8	4x110	4+4	ET-10	UR128110	12x1,50	UR12150
	Front	14X7	4x110	4+3	ET2.5	UR147110	12x1,50	UR12150
	Rear	14X8	4x110	4+4	ET-10	UR148110	12x1,50	UR12150

** 2" spacer må benyttes



OBS!
URA SPLINES MUTTERE
MÅ BENYTTES PÅ
URA RAPTOR

HONDA forts.

			BOLT SIRKEL	OFFSET	ET	VARE# FELG	MUTTER STINGNING	VARE# MUTTER
PIONEER 500/700 14-	Front	12X7	4x110	4+3	ET2.5	UR127110	12x1,50	UR12150
	Rear	12X8	4x110	4+4	ET-10	UR128110	12x1,50	UR12150
	Front	14X7	4x110	4+3	ET2.5	UR147110	12x1,50	UR12150
	Rear	14X8	4x110	4+4	ET-10	UR148110	12x1,50	UR12150
PIONEER 1000 16-17	Front	12X7	4x136	4+3	ET2.5	UR127136	12x1,50	UR12150
	Rear	12X8	4x136	4+4	ET-10	UR128136	12x1,50	UR12150
	Front	14X7	4x136	4+3	ET2.5	UR147136	12x1,50	UR12150
	Rear	14X8	4x136	4+4	ET-10	UR148136	12x1,50	UR12150

KAWASAKI

BRUTE FORCE 650I 4X4 06-16 (IRS MODEL)	Front	12X7	4x110	4+3	ET2.5	UR127110	10x1,25	UR10125
	Rear	12X8	4x110	4+4	ET-10	UR128110	10x1,25	UR10125
	Front	14X7	4x110	4+3	ET2.5	UR147110	10x1,25	UR10125
	Rear	14X8	4x110	4+4	ET-10	UR148110	10x1,25	UR10125
BRUTE FORCE 750 4X4 05-17	Front	12X7	4x110	4+3	ET2.5	UR127110	10x1,25	UR10125
	Rear	12X8	4x110	4+4	ET-10	UR128110	10x1,25	UR10125
	Front	14X7	4x110	4+3	ET2.5	UR147110	10x1,25	UR10125
	Rear	14X8	4x110	4+4	ET-10	UR148110	10x1,25	UR10125
TERYX 750/800 08-17	Front	12X7	4x136	4+3	ET2.5	UR127136	12x1,25	UR12125
	Rear	12X8	4x136	4+4	ET-10	UR128136	12x1,25	UR12125
	Front	14X7	4x136	4+3	ET2.5	UR147136	12x1,25	UR12125
	Rear	14X8	4x136	4+4	ET-10	UR148136	12x1,25	UR12125
MULE 550/600/610 ALL YEARS	Front	12X7	4x136	4+3	ET2.5	UR127136	10x1,25	UR10125
	Rear	12X8	4x136	4+4	ET-10	UR128136	10x1,25	UR10125
MULE 2500/3000/4010 SERIES* *Hevesett behøves for mer enn 26" dekk	Front	12X7	4x136	4+3	ET2.5	UR127136	12x1,25	UR12125
	Rear	12X8	4x136	4+4	ET-10	UR128136	12x1,25	UR12125
	Front	14X7	4x136	4+3	ET2.5	UR147136	12x1,25	UR12125
	Rear	14X8	4x136	4+4	ET-10	UR148136	12x1,25	UR12125

KYMCO

500MUX SA 08-10/MXU IE 08-11/500 UXV 10	Front	12X7	4x110	4+3	ET2.5	UR127110	10x1,25	UR10125
	Rear	12X8	4x110	4+4	ET-10	UR128110	10x1,25	UR10125

POLARIS

SPORTSMAN 335 99-06	Front	12X7	4x156	4+3	ET2.5	UR127156	3/8"	UR00038
	Rear	12X8	4x156	4+4	ET-10	UR128156	3/8"	UR00038
	Front	14X7	4x156	4+3	ET2.5	UR147156	3/8"	UR00038
	Rear	14X8	4x156	4+4	ET-10	UR148156	3/8"	UR00038
SPORTSMAN 400/450 01-16	Front	12X7	4x156	4+3	ET2.5	UR127156	3/8"	UR00038
	Rear	12X8	4x156	4+4	ET-10	UR128156	3/8"	UR00038
	Front	14X7	4x156	4+3	ET2.5	UR147156	3/8"	UR00038
	Rear	14X8	4x156	4+4	ET-10	UR148156	3/8"	UR00038

** 2" spacer må benyttes

POLARIS forts.

			BOLT SIRKEL	OFFSET	ET	VARE# FELG	MUTTER STINGNING	VARE# MUTTER
SPORTSMAN 500 96-13	Front	12X7	4x156	4+3	ET2.5	UR127156	3/8"	UR00038
	Rear	12X8	4x156	4+4	ET-10	UR128156	3/8"	UR00038
	Front	14X7	4x156	4+3	ET2.5	UR147156	3/8"	UR00038
	Rear	14X8	4x156	4+4	ET-10	UR148156	3/8"	UR00038
MAGNUM 500 02-06	Front	12X7	4x156	4+3	ET2.5	UR127156	3/8"	UR00038
	Rear	12X8	4x156	4+4	ET-10	UR128156	3/8"	UR00038
	Front	14X7	4x156	4+3	ET2.5	UR147156	3/8"	UR00038
	Rear	14X8	4x156	4+4	ET-10	UR148156	3/8"	UR00038
SPORTSMAN 570 14-16	Front	12X7	4x156	4+3	ET2.5	UR127156	3/8"	UR00038
	Rear	12X8	4x156	4+4	ET-10	UR128156	3/8"	UR00038
	Front	14X7	4x156	4+3	ET2.5	UR147156	3/8"	UR00038
	Rear	14X8	4x156	4+4	ET-10	UR148156	3/8"	UR00038
SPORTSMAN 600 03-09	Front	12X7	4x156	4+3	ET2.5	UR127156	3/8"	UR00038
	Rear	12X8	4x156	4+4	ET-10	UR128156	3/8"	UR00038
	Front	14X7	4x156	4+3	ET2.5	UR147156	3/8"	UR00038
	Rear	14X8	4x156	4+4	ET-10	UR148156	3/8"	UR00038
SPORTSMAN 700 02-09	Front	12X7	4x156	4+3	ET2.5	UR127156	3/8"	UR00038
	Rear	12X8	4x156	4+4	ET-10	UR128156	3/8"	UR00038
	Front	14X7	4x156	4+3	ET2.5	UR147156	3/8"	UR00038
	Rear	14X8	4x156	4+4	ET-10	UR148156	3/8"	UR00038
SPORTSMAN 800 05-14	Front	12X7	4x156	4+3	ET2.5	UR127156	3/8"	UR00038
	Rear	12X8	4x156	4+4	ET-10	UR128156	3/8"	UR00038
	Front	14X7	4x156	4+3	ET2.5	UR147156	3/8"	UR00038
	Rear	14X8	4x156	4+4	ET-10	UR148156	3/8"	UR00038
SPORTSMAN XP 550/700/800/850 09-17*	Front	12X7	4x156	4+3	ET2.5	UR127156	10x1,25	UR10125
	Rear	12X8	4x156	4+4	ET-10	UR128156	10x1,25	UR10125
	Front	14X7	4x156	4+3	ET2.5	UR147156	10x1,25	UR10125
	Rear	14X8	4x156	4+4	ET-10	UR148156	10x1,25	UR10125
* SPORTSMAN XP 2009 blir 5" bredere etter montering	Front	12X7	4x156	4+3	ET2.5	UR127156	3/8"	UR00038
	Rear	12X8	4x156	4+4	ET-10	UR128156	3/8"	UR00038
	Front	14X7	4x156	4+3	ET2.5	UR147156	3/8"	UR00038
	Rear	14X8	4x156	4+4	ET-10	UR148156	3/8"	UR00038
SPORTSMAN X2 500/550/800 09-15	Front	12X7	4x156	4+3	ET2.5	UR127156	3/8"	UR00038
	Rear	12X8	4x156	4+4	ET-10	UR128156	3/8"	UR00038
	Front	14X7	4x156	4+3	ET2.5	UR147156	3/8"	UR00038
	Rear	14X8	4x156	4+4	ET-10	UR148156	3/8"	UR00038
SPORTSMAN ACE 570/900 14-16	Front	12X7	4x156	4+3	ET2.5	UR127156	3/8"	UR00038
	Rear	12X8	4x156	4+4	ET-10	UR128156	3/8"	UR00038
	Front	14X7	4x156	4+3	ET2.5	UR147156	3/8"	UR00038
	Rear	14X8	4x156	4+4	ET-10	UR148156	3/8"	UR00038
RANGER 570 (FULLSIZE) 14-16	Front	12X7	4x156	4+3	ET2.5	UR127156	12x1,50	UR12150
	Rear	12X8	4x156	4+4	ET-10	UR128156	12x1,50	UR12150
	Front	14X7	4x156	4+3	ET2.5	UR147156	12x1,50	UR12150
	Rear	14X8	4x156	4+4	ET-10	UR148156	12x1,50	UR12150
RANGER XP900 & DIESEL 14-17	Front	12X7	4x156	4+3	ET2.5	UR127156	12x1,50	UR12150
	Rear	12X8	4x156	4+4	ET-10	UR128156	12x1,50	UR12150
	Front	14X7	4x156	4+3	ET2.5	UR147156	12x1,50	UR12150
	Rear	14X8	4x156	4+4	ET-10	UR148156	12x1,50	UR12150
RANGER ETX/570/EV/ 800 6X6 4X4 03-17	Front	12X7	4x156	4+3	ET2.5	UR127156	3/8"	UR00038
	Rear	12X8	4x156	4+4	ET-10	UR128156	3/8"	UR00038
	Front	14X7	4x156	4+3	ET2.5	UR147156	3/8"	UR00038
	Rear	14X8	4x156	4+4	ET-10	UR148156	3/8"	UR00038
RANGER 400 / 400EV 10-14	Front	12X7	4x156	4+3	ET2.5	UR127156	3/8"	UR00038
	Rear	12X8	4x156	4+4	ET-10	UR128156	3/8"	UR00038
	Front	14X7	4x156	4+3	ET2.5	UR147156	3/8"	UR00038
	Rear	14X8	4x156	4+4	ET-10	UR148156	3/8"	UR00038
RZR 800/900XP 08-14 & RZR 570 14-17	Front	12X7	4x156	4+3	ET2.5	UR127156	3/8"	UR00038
	Rear	12X8	4x156	4+4	ET-10	UR128156	3/8"	UR00038
	Front	14X7	4x156	4+3	ET2.5	UR147156	3/8"	UR00038
	Rear	14X8	4x156	4+4	ET-10	UR148156	3/8"	UR00038
RZR 900/900 XC/900 S 15-16 / RZR 1000 14-1	Front	12X7	4x156	4+3	ET2.5	UR127156	12x1,50	UR12150
	Rear	12X8	4x156	4+4	ET-10	UR128156	12x1,50	UR12150
	Front	14X7	4x156	4+3	ET2.5	UR147156	12x1,50	UR12150
	Rear	14X8	4x156	4+4	ET-10	UR148156	12x1,50	UR12150

** 2" spacer må benyttes



SUZUKI			BOLT SIRKEL	OFFSET	ET	VARE# FELG	MUTTER STINGNING	VARE# MUTTER
KING QUAD 400 (STRAIGHT AXLE) 4X4 08-16	Front	12X7	4x110	4+3	ET2.5	UR127110	10x1,25	UR10125
	Rear	12X8	4x110	2+6	ET-10**	UR148110**	10x1,25	UR10125
EIGER 400 4X4 02-07	Front	12X7	4x110	4+3	ET2.5	UR127110	10x1,25	UR10125
	Rear	12X8	4x110	2+6	ET-10**	UR148110**	10x1,25	UR10125
VINSON 500 4X4 02-08	Front	12X7	4x110	4+3	ET2.5	UR127110	10x1,25	UR10125
	Rear	12X8	4x110	2+6	ET-10**	UR148110**	10x1,25	UR10125
KING QUAD 450/700/750 05-17	Front	12X7	4x110	4+3	ET2.5	UR127110	10x1,25	UR10125
	Rear	12X8	4x110	4+4	ET-10	UR128110	10x1,25	UR10125
	Front	14X7	4x110	4+3	ET2.5	UR147110	10x1,25	UR10125
	Rear	14X8	4x110	4+4	ET-10	UR148110	10x1,25	UR10125
YAMAHA								
GRIZZLY 350 (STRAIGHT AXLE) 4X4 08-10	Front	12X7	4x110	4+3	ET2.5	UR127110	10x1,25	UR10125
	Rear	12X8	4x110	2+6	ET-10**	UR148110**	10x1,25	UR10125
BIG BEAR 350/400 2X4/4X4 87-06	Front	12X7	4x110	4+3	ET2.5	UR127110	10x1,25	UR10125
	Rear	12X8	4x110	2+6	ET-10**	UR148110**	10x1,25	UR10125
WOLVERINE 350/450 4X4 95-08	Front	12X7	4x110	4+3	ET2.5	UR127110	10x1,25	UR10125
	Rear	12X8	4x110	2+6	ET-10**	UR148110**	10x1,25	UR10125
BRUIN 350 2X4/4X4 04-06	Front	12X7	4x110	4+3	ET2.5	UR127110	10x1,25	UR10125
	Rear	12X8	4x110	2+6	ET-10**	UR148110**	10x1,25	UR10125
GRIZZLY 350 IRS 07-15	Front	12X7	4x110	4+3	ET2.5	UR127110	10x1,25	UR10125
	Rear	12X8	4x110	4+4	ET-10	UR128110	10x1,25	UR10125
	Front	14X7	4x110	4+3	ET2.5	UR147110	10x1,25	UR10125
	Rear	14X8	4x110	4+4	ET-10	UR148110	10x1,25	UR10125
BIG BEAR 400 IRS 07-12	Front	12X7	4x110	4+3	ET2.5	UR127110	10x1,25	UR10125
	Rear	12X8	4x110	4+4	ET-10	UR128110	10x1,25	UR10125
	Front	14X7	4x110	4+3	ET2.5	UR147110	10x1,25	UR10125
	Rear	14X8	4x110	4+4	ET-10	UR148110	10x1,25	UR10125
KODIAK 400/450 4X4 93-04	Front	12X7	4x110	4+3	ET2.5	UR127110	10x1,25	UR10125
	Rear	12X8	4x110	2+6	ET-10**	UR148110**	10x1,25	UR10125
KODIAK 400/450 4X4 05-06	Front	12X7	4x110	4+3	ET2.5	UR127110	10x1,25	UR10125
	Rear	12X8	4x110	4+4	ET-10	UR128110	10x1,25	UR10125
	Front	14X7	4x110	4+3	ET2.5	UR147110	10x1,25	UR10125
	Rear	14X8	4x110	4+4	ET-10	UR148110	10x1,25	UR10125
GRIZZLY 400/450/550/700 4X4 07-17	Front	12X7	4x110	4+3	ET2.5	UR127110	10x1,25	UR10125
	Rear	12X8	4x110	4+4	ET-10	UR128110	10x1,25	UR10125
	Front	14X7	4x110	4+3	ET2.5	UR147110	10x1,25	UR10125
	Rear	14X8	4x110	4+4	ET-10	UR148110	10x1,25	UR10125
GRIZZLY 600 4X4 98-01	Front	12X7	4x110	4+3	ET2.5	UR127110	10x1,25	UR10125
	Rear	12X8	4x110	2+6	ET-10**	UR148110**	10x1,25	UR10125
GRIZZLY 660 02-09	Front	12X7	4x110	4+3	ET2.5	UR127110	10x1,25	UR10125
	Rear	12X8	4x110	4+4	ET-10	UR128110	10x1,25	UR10125
	Front	14X7	4x110	4+3	ET2.5	UR147110	10x1,25	UR10125
	Rear	14X8	4x110	4+4	ET-10	UR148110	10x1,25	UR10125
RHINO 450/660/700 04-13	Front	12X7	4x110	4+3	ET2.5	UR127110	10x1,25	UR10125
	Rear	12X8	4x110	4+4	ET-10	UR128110	10x1,25	UR10125
	Front	14X7	4x110	4+3	ET2.5	UR147110	10x1,25	UR10125
	Rear	14X8	4x110	4+4	ET-10	UR148110	10x1,25	UR10125

** 2" spacer må benyttes

FELGER MED BORING

IFOR WILLIAMS



	Størrelse		Farge	Utførelse	Boltsirkel	Nav	ET
12"							
RW1245500	4.50 x 12	155/70R12C	Sølv	Sveist	5x165,1	114,5	0
RW1255500	5.50 x 12	185/60R12C - 195/60R12C	Sølv	Sveist	5x165,1	115	0
STF39600287	6.00 x 12	185/60R12C - 195/60R12C	Sølv	Sveist	5x165,1	114,5	0
13"							
RW1345426	4.50 x 13	155/70R13C - 155/80R13C 175/80R13C	Sølv	Sveist	4x139,7	95,5	26
RW1306507	6.00 x 13	195/50R13C	Sølv	Sveist	5x165,1	115	7
16"							
STF39600328	5.00 x 16	175/75R16C	Sølv	Sveist	5x165,1	115	39,7



I vår b2b nettbutikk kan en søke etter ATV dekk på ulike måter:

1. **Søk med reg nr;** Når en søker med reg nummer, vil netbutikken sjekke dekkdimensjoner, hastighetsmerkinger og loadindeks fra vogn kort. Klikk på kjøretøy for å velge fordekk eller bakdekk.
2. **Søk etter dekkdimensjon;** Viser kun dekkdimensjon det blir søkt etter. Alternative dekkdimensjoner vil ikke vises.
3. **Avansert søk;** Viser alle tilgjengelige dekk på samme søk. En bruker da filteret i venstre kolonne for å filtrere etter merker, mønster og dimensjoner. Veldig greit verktøy når en skal søke på ATV-dekk. Viser da både fordekk og bakdekk på samme søk. Kan eksempelvis legge inn dekk med 26" i diameter og og 14" felg diameter. Viser da 26" x 8/9/10/11/12 -(R) 14" dekk.

NB! Husk at hvis en øker diameter på en 4x4 ATV/UTV, må diameteren økes litt både foran og bak.



Søk ATV felger:

Reg nummer kan **ikke** benyttes ved søk etter ATV felger, da vogllister ikke klarer matche reg nummer fra vegvesenet. De fleste ATV og UTV kan registreres på ulike måter og får derfor ulike typebetegnelse.

Benytt derfor vognlisten (side 36-40) for å finne boltsirkel og anbefalte felgstørrelser foran og bak. Vi anbefaler å bruke ulike bredder på de fleste 4x4, da de som oftest har ulike dekkdimensjoner originalt. Husk å sjekke innpress, da det på enkelte modeller varierer.

OBS! Sporvidde økes på de aller fleste modeller grunnet lavere innpress enn originalt.

<https://b2b.norgesdekk.no>

24t

Ønsker du å bestille varer utenom våre åpningstider?
Er du kunde hos oss, kan du raskt og enkelt få tilgang til vår nettbutikk. Kontakt en av våre selgere, eller send epost til b2b.norgesdekk.no

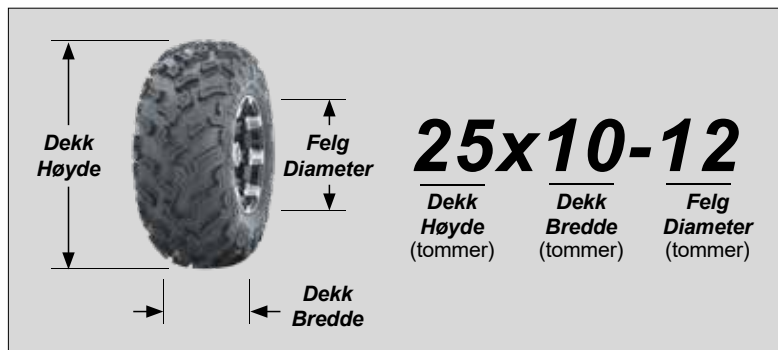

1. Tall = Den totale dekkhøyde når luftfylt (Eks 25x10-12 er 25" høyt)
2. Tall = Den totale dekkbredde når luftfylt (Eks 25x10-12 er 10" bredt)
Hvis "-" følger, er det et Diagonaldekk. Eks 25x10-12
Hvis bokstaven "R" følger, er det et Radialdekk. Eks 25x10R12
3. Tall = Felgdiameter (Eks 25x10-12 er 12" i diameter)

FELGER MED NAV

KULELAGER

PART #		Felger				PART #	
Type	Størrelse	Ø mm	B mm	Dekkdimensjon	Akseltapper og bolter		
					Diameter/lengde mm		
3"							
STN4004	GG 1.50x3 Delt	12	85	2.50 - 3	RW4681	12x120	
STN4008	EK 1.50x3 Delt	20	50	2.50 - 3			
4"							
STN4012	TK 2.10x4 Delt	25	110	3.00/4.00 - 4	RW4693	25x300	
STN4014	GK 2.10x4 Sveist	12	95	3.00/4.00 - 4	RW4681	12x120	
STN4170	GK 2.10x4 Sveist	20	75	3.00/4.00 - 4			
STN4015	EK 2.10x4 Sveist	25	75	3.00/4.00 - 4	RW4688	25x230	
STN4018	EK 2.10x4 Delt	25	75	3.00/4.00 - 4	RW4688	25x230	
STNB5332V	GK 2.10x4 Delt	12	95	3.00/4.00 - 4	RW4701	12x150	
STN4026	GK 2.10x4 Sveist	12	120	3.00/4.00 - 4	RW4701	12x150	
STN4025	GK 2.10x4 Delt Forsterket	16	120	3.00/4.00 - 4	RW4711	16x150	
6"							
STN4042	TK 2.50x6 Sveist	25	110	4.00 - 6	RW4693	25x300	
STN4044	GK 2.50x6 Sveist	16	120	4.00 - 6	RW4711	16x150	
STN4048	EK 2.50x6 Sveist	30	75	13x5.00 - 6	RW4692	30x240 LÅSEM.	
STN4043	TK 4.50x6 Sveist	25	180			25x270	
STN4053	GK 4.50x6 Delt Forsterket	16	180	LP-140 - 6	RW4723	16x220	
STN4045	GK 4.50x6 Sveist	16	180	13x6.50 - 6	RW4723	16x220	
STN4050	EK 4.50x6 Sveist	30	100	15x6.00 - 6	RW4741	30x256 LÅSEM.	
8"							
STN4052	TK 2.50x8 Sveist	25	110	4.00 - 8	RW4693	25x300 LÅSR.	
STN4054	GK 2.50x8 Sveist	16	120	4.00 - 8	RW4711	16x150	
STN4058	EK 2.50x8 Sveist	20/25	85	4.00 - 8	RW4692	30x240 LÅSEM.	
STN4060	EK 2.50x8 Sveist	25	70	4.00 - 8			
STN4064	GK 3.00x8 Sveist	16	145	5.00 - 8	RW4721	16x180	
STN4068	EK 3.00x8 Sveist	30	80		RW4741	30x256 LÅSEM.	
STNB5350	GK 5.50x8 Sveist	16	200	16x6.50/18x7-8			
STN4076	EK 7.00x8 Sveist	20/25	95	18x8.50/9.50-8	RW4746	35x273 LÅSEM.	
9"							
STN4078	EK 4.00x9 Sveist	30	100	6.00 - 9	RW4741	30x150 LÅSEM.	
12"							
STN4084	GK 4.00x12 Sveist	16	180	6.00 - 12	RW4723	16x220	

Finn korrekt felgstørrelse og -type (TK, GK, EK) i tabellen over. For hver felg er det oppgitt navåpning og bredde på navrøret. På noen felger kan lager byttes slik at felgen kan tilpasses 20 eller 30 mm bolt.

Ø mm = navhullsdiameter

B mm = navbredde

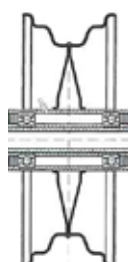

TK

TK felg:
Sveist felg for montering på gjennomgående glatt aksel. Leveres med kulelager.

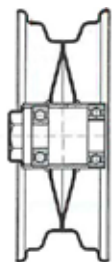

EK

EK felg:
Sveist endenavsfelg for montering på aksel. Leveres med kulelager og ofte med 2 ulike lagerstørrelser.

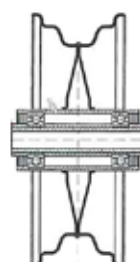

GK

GK felg:
Sveist felg for gaffelmontering. Leveres med kulelager.

FELGER MED NAV RULLELAGER - GLIDELAGER

PART #		PART #				
Type	Størrelse	Felger			Akseltapper og bolter	
		Ø mm	B mm	Dekkdimensjon	Akseltapp	
STNB4823	GR 200x50 Sveist	20	60	200 x 50		
3"						
STN4105	EG 1.50X3 Delt	25	60	2.50 - 3	RW4751	25x155
4"						
STN4169	ER 2.10x4 Sveist	20	75	3.00/4.00 - 4	-	-
STN4112	GG 2.10x4 Sveist	12	88	3.00/4.00 - 4	RW4681	(kan kuttes)
STN4116	EG 2.10x4 Sveist	25	85	3.00/4.00 - 4	RW4761	25x240
STN4122	TG 2.10x4 Sveist	20	120	3.00/4.00 - 4	RW4758	20x300
STN4122GG	GG 2.10x4 Sveist	12	120	3.00/4.00 - 4	RW4701	12x150
STN4123	GG 2.10X4 Delt	20	95	3.00/4.00 - 4		
6"						
STN4132	TG 2.50x6 Sveist	20	120	4.00 - 6	RW4758	20x300
STN4133	GG 2.50x6 Sveist	16	120	4.00 - 6	RW4711	16x150
STN4135	EG 2.50x6 Sveist	25	85	13x5.00 - 6	4761	25x240
8"						
STN4144	TG 2.50x8 Sveist	20	120	4.00 - 8	RW4758	20x300
STN4144GG	GG 2.50x8 Sveist	25	120	4.00 - 8	RW4711	16x150
STN4145	EG 2.50x8 Sveist	25	85	4.00 - 8	RW4761	25x240
STN4148	TG 2.50x8 Sveist	25	85	4.00 - 8	RW4761	25x240

FELGER MED NAV KUNSTOFF

PART #		PART #				
Størrelse	Felger			Akseltapper og bolter		
	Ø mm	B mm	Dekkdimensjon	Akseltapp		
4"						
FMN4182	2.10x4	20/25	85	3.00/4.00-4	-	-
6"						
FMNB5007C	2.50x6	20	120	4.00-6	-	-
8"						
FMN4184	2.50x8	25	85	4.00-8	RW4761	25x240

*Felgene kan leveres med 25 alternativt 20mm foring/navåpning

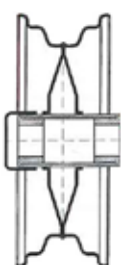

EG felg:
Sveist endenavsfelg for montering på aksel. Leveres med glidelager.

EG



TG felg:
Sveist felg for gaffelmontering. Leveres med glidelager

TG

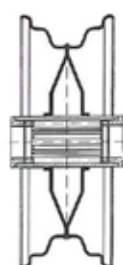

GR felg:
Sveist felg for gaffelmontering. Leveres med rullelager

GR

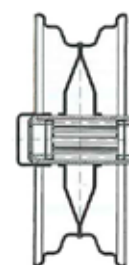

ER felg:
Sveist endenavsfelg for montering på aksel. Leveres med rullelager.

ER

FELGER MED BORING

TILHENGERE - CAMPINGVOGNER - ETC





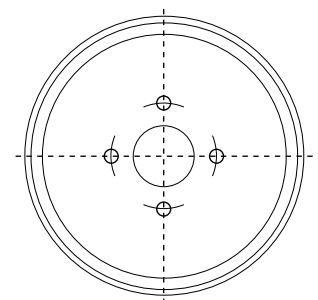

	Størrelse	For Dekkdim.	Farge	Utførelse	Boltsirkel	Nav	ET	Tilpasset nav
8"								
STF4200	2.50 x 8	4.00-8	Grå	Sveist	3x88.5	65.1	0	-
STF4210	2.50 x 8		Grå	Sveist	4x101	68	0	-
STF4220	2.50 x 8		Sølv	Sveist	4x100	60	0	B7040,B7039A,4571
STF4230	2.50 x 8		Sølv	Sveist	5x115	80	0	4530, 4572, B7045, 4605, 4632
STF4242	3.00 x 8	4.00/5.00-8	Sølv	Delt 3.0 mm	5x115	80	0	
STF4250	3.00 x 8	5.00-8	Sølv	Sveist	4x100	60	0	B7039A,4571,B7040
STF4260	3.00 x 8		Sølv	Sveist	4x101	68	0	-
STF4270	3.00 x 8		Sølv	Sveist	5x115	80	0	
STF4273	3.75 x 8	5.00x8, 125/75R8	Sølv	Forst. 5mm	5x115	80	0	4605, 4610, 4612, 4530, 4572, B7045, 4632, B7045A
STF4281	5.50 x 8	LP190-8	Sølv	Sveist	5x115	80	0	
STF4282	5.50 x 8	16.5-6.50/LP190-8	Sølv	Sveist	4x100	60	0	4571, B7040, B7039A
STF4284	7.00 x 8	18x8.50-21x11.00-8	Sølv	Sveist	4x100	60	0	
STF4285	7.00 x 8		Rød	Sveistrød	5x115	80	0	4530,4572,4632
STF4288	8.50 x 8	22x11.00-8	Sølv	Sveist	4x100	60	0	4570, 4632
STF4290	4.33 x 8	18x7-8 truck	Rød	Delt	6x140	100	0	4614, 4540, 4550
9"								
STF4300	4.00 x 9	6.00-9	Rød	Sveist	5x115	80	0	4605, 4610, 4530, 4572, B7045
STF4310	4.00 x 9		Rød	Delt	5x115	80	0	
STF4316	4.00 x 9		Rød	Delt	6x140	100	0	4540, 4550, 4614, 4575, 4576, 4635
STF4318	6.00 x 9	21x8-9	Rød	Delt	6x140	100	0	
10"								
RW1035435	3.50 x 10	5.00/145-10	Sølv	Sveist	4x100	60	0	4571, 4570, B7039A
STF4330	3.50 x 10		Sølv	Sveist	4x101	68	0	-
STF4340	3.50 x 10		Sølv	Sveist	5x115	80	0	4530, 4572, B7045
STF4360	5.50 x 10	7.50-10 (9.00-10)	Sølv	Delt	6x140	100	0	4614, 4550, 4576
STFB5055C	6.00 x 10	195/55, 20.5x8.0-10	Sølv	Sveist	5x112	67	0	-
STF4371	6.00 x 10	20x8.00-10	Sølv	Sveist	4x100	60	0	4571, 4570, 7039A
STF4376	7.00 x 10	20x10.00-10	Sølv	Sveist	4x100	60	0	
STF4382	7.00 x 10		Sølv	Sveist	5x115	80	0	4530, 4572, B7045
STF4351	8.50 x 10	20x11/12.5, 20.5x10	Sølv	Sveist	4x100	60	0	4570, 4571
12"								
STFB5056	4.00 x 12	6.00-12, 155/70R12	Sølv	Sveist	4x100	60	0	4570, 4571
STFB5062	7.00 x 12	10.0/80-12 Landbruk	Sølv	Sveist	5x115	80	0	4530, 4572, B7045 B7045A
STF4398	7.00 x 12	23x10.50-12 Gress	Sølv	Sveist	5x115	80	0	
STF4400	7.00 x 12	8.50/10.0/80-12	Sølv	Sveist	6x140	100	0	4540, 4550, 4576
STF4397	8.50 x 12	25x10/11-12	Sølv	Sveist	4x100	60	0	4570
STF4404	10.50 x 12	26x12.00-12	Sølv	Sveist	5x115	80	0	4530, 4572, B7045
13" t.o.m 15"								
RW1345430	4.50 x 13	155/80-185/70 R13	Sølv	Sveist	4x100	60	ET30	-
RW1345530	4.50 x 13	155R13, 165R13	Sølv	Sveist	5x112	67	ET30	-
STFB5067A	5.50 x 13	185/70R13	Sølv	Sveist	5x112	66	ET30	-
RW1455430	5.50 x 14	185/65R14	Sølv	Sveist	4x100	57	ET30	-
RW1455530	5.50 x 14	195/70R14	Sølv	Sveist	5x112	67	ET30	-
STF4406	6.75 x 14.5	200/60-14.5	Sølv	Sveist	5x115	80	0	4530, B7045
RW1506530	6.00 x 15	175/65R15	Sølv	Sveist	5x112	6.6	ET30	-

Landbruksfelger f.o.m 15", Se vår landbruksliste.







NAV FOR GAFFELMONTERING

   							
Nav	Lager	Boltsirkel	Nav	Boltstørrelse mm	Gaffel vidde mm	Belastning v/ 40km/t	
NAV4605	GAF-3511	2x6205	5x115	80	M12x1.5	145/ø17	750
NAV4610	GAF-7035	2x6206	5x115	80	M12x1.5	145/ø20,4	1000
NAV4612	GAF-3389	2x30206	5x115	80	M12x1.5	180/ø20	900
NAVB7036	7036	2x6206	5x115	80	M12x1.5	180/ø20,4	1000
NAV4614	GAF-9486	2x32207	6x140	100	M16x1.5	250/ø24	2200
NAV4728	Stålbolt til	4614			M24x360		
NAV4630	42S-5519	2x30207	6x140	100	M16x1.5	225 m/bolt	1200
NAV4630UF	42 u/fester	2x30207	6x140	100	M16x1.5	225 m/bolt	1200





LØST NAV UTEN AKSELTAPP
AKSELTAPP

  							
Boring	Lager	Boltstørrelse i mm	Belastning v/ 40 km/t	Pris	Diam. i mm		
NAV4530/21	80-115- 5	30205-30207	M12x1.5	900	875,-	RW4831	45
NAV4540/22	100-140- 6	30206-30209	M16x1.5	1.685	1485,-	RW4841	60
NAV4550/23	100-140- 6	30207-30210	M16x1.5	2.100	1785,-	RW4851	65

NAV MED AKSELTAPP

   							
Nav	Lager	Boltsirkel	Nav	Akseltapp dim./lengde	Boltdiameter mm	Belastning v/ 40 km/t	
NAVB7040	7040	30204-30205	4x100	59	Ø 35x200	M12x1.5	425
NAV4571	7041	30204-30206	4x100	56	Ø 40x200	M12x1.5	650
NAV4570	1006	30204-30206	4x100	57	40x40x215	M12x1.5	700
NAV4572	1005	30204-30205	5x115	80	Ø 35x100	M12x1.5	500
NAVB7045	7045	30205/30207	5x115	80	Ø 40x200	M12x1.5	915
NAV4575	7058	30208-30211	6x205	161	Ø 60x200	M18x1.5	1900
NAV4576	1024	30208-30211	6x205	161	60x60x355	M18x1.5	2400
NAV4580	1027	30209-30212	6x205	161	70x70x300	M18x1.5	2800
NAV4582	1034	32210-32213	6x205	161	80x80x350	M18x1.5	3400
NAVB7075	skaffevare	32211-32215	8x275	221	90x90x475	M22x1.5	4500

NAV MED AKSELTAPP OG BREMS (av/på)

   							
Nav	Lager	Boltsirkel	Nav	Akseltapp	Boltdiameter mm	Belastning v/ 40 km/t	Brems
NAVN670-27	Sylinder for utv. montering						
NAVB7039A	7039A	30204-30205	4x100	56	Ø35x200	M12x1.5	425 140-30
NAV4632	2005	30204-30205	5x115	80	Ø35x100	M12x1.5	500 135-30
NAVB7045A	7045A	30205-30207	5x115	80	Ø40x200	M12x1.5	900 200-40
NAV4635	2020	30206-30209	6x205	161	60x60x200	M18x1.5	2000 250-40
NAVB7097	Tuv godkjent	30208-30211	6x205	161	60x60x201	M18x1.5	2200 300-60
NAV4640	3027	30208-30213	6x205	161	70x70x300	M18x1.5	2750 300-60
NAV4645	3046	32211-32215	6x205	161	90x90x350	M18x1.5	4500 300-90
NAVB7099	7099 (H)	32211-32215	8x275	221	90x90x375	M22x1.5	4500 350-100
NAV4647	3048	32212-32215	8x275	221	90x90x350	M18x1.5	4500 300-90

(H) = Hydraulisk Cylinder

GALVANISERTE GAFLER

PLATE 100X100MM

PART
#



Type	Utførelse	Gaffelbredde mm	Max Belastning Kg	For Dekkdimensjon	
DGT					
RW4905-08	DGT	Med Tapp		3.00-4, 4.00-4 og 4.00-6	
DGP					
RW4910	DGP- 8	Dreibar gaffel m/plate	90	200	2.50-3
RW4912	DGP-10		120	300	3.00-4
RW4914	DGP-12		120	350	4.00-4
RW4915	DGP-14		120	350	4.00-6
RW4916	DGP-16		120	400	4.00-8
FGP					
RW4918	FGP- 8	Fast gaffel m/plate	90	200	2.50-3
RW4920	FGP-10		90	300	3.00-4
RW4922	FGP-12		120	350	4.00-4
RW4923	FGP-14		120	350	4.00-6
RW4925	FGP-16		120	400	4.00-8
TILBEHØR					
RWB6035	Brems	til art. 4903-4907 og 4910-4914			

DGP



DGT



FGP



PART
#



	Merke	Dekkdimensjon
6"		
RW3405	Røwde	13x6.50/15x6.00/LP 140 - 6
8"		
RW3409	Røwde	4.00 - 8
SX4005008	Starmaxx	4.00/5.00 - 8
RW3410	Røwde	5.00/18 x 7/LP 190 - 8
SX1878	Starmaxx	18x7.00-8
9"		
SX6009	Starmaxx	6.00 - 9
SX2189	Starmaxx	21x8 - 9
RW3420	Røwde	6.00/21x8 - 9
10"		
RW3430	Røwde	6.50/7.50/9.5 - 10
SX65010	Starmaxx	6.50 - 10 23x9.00 - 10
12"		
RW3434	Røwde	7.00 - 12
SX70012	Starmaxx	7.00 - 12
SX271012	Starmaxx	27x10.00 - 12
15"		
RW3437	Røwde	250/300 - 15
RW3438	Røwde	6.50/7.00/7.50/8.15/8.25 - 15
SX81582515	Starmaxx	8.15/8.25 - 15
16"		
RW3442	Røwde	6.50/7.00 - 16
SX70016	Starmaxx	7.00 - 16
RW3443	Røwde	7.50/8.25 - 16
20"		
RW3444	Røwde	6.50/7.50 - 20
RW3445	Røwde	8.25/9.00 - 20
RW3446	Røwde	10.00/12.00 - 20
SX10111220	Starmax	10.00/12.00 - 20
24-25"		
RW3449	Røwde	13.00/14.00 - 24/25
RW3450	Røwde	16.00 - 24/25
RW3451	Røwde	20.50 - 25
RW3455	Røwde	23.50/26.50 - 25



SLANGER

SMÅDEKK TR13 OG TR87/DIN7777

Dimensjon	Ventil	Merke	Varenummer	Kartong	Merke	Varenummer	Kartong
4"							
2.50/3.00-4	TR13	Duro	DU3021	100 stk			
3.50/4.00-4	TR13	Duro	DU3031	50 stk			
5"							
4.10/3.50-5	TR13				Røwde	RW3034	75 stk
6"							
2.00-6	TR13				Røwde	RW3050B	-
2.50-6	TR13	Brix	BX1816	50 stk			
3.50/4.00-6	TR13	Duro	DU3060	50 stk	Røwde	RW3060	75 stk
7"							
3.50/4.00-7	TR13	Norgesdekk	ND29800069	-			
8"							
2.50-8	TR13				Røwde	RW3072	
3.50/4.00-8	TR13	Duro	DU3070	50 stk	Røwde	RW3070	75 stk
5.00-8	TR13				Røwde	RW3080	50 stk
10"							
3.00/3.50/4.00-10	TR13				Røwde	RWB1852A	50 stk
5.00-10/145-10	TR13				Røwde	RW3803	50 stk
7.50-10	TR13				Røwde	RW3130	-
9.00/9.50-10	TR13				Røwde	RW3140	-
12"							
4.00-12/125-12	TR13				Røwde	RW3141	-
6.00-12	TR13				Røwde	RW3143	30 stk
12.5"							
12.5x2 1/4	TR13				Røwde	RWB1181	50 stk

Dimensjon	Ventil	Merke	Varenummer	Kartong	Merke	Varenummer	Kartong
t.o.m 4"							
200x50 8x2	TR87				Røwde	RW3001	50 stk
2.50-3	TR87	Duro	DU3010	50 stk			
2.50/3.00-4	TR87	Duro	DU3020	50 stk	Røwde	RW3020	100 stk
3.50/4.00-4	TR87	Duro	DU3030	50 stk	Røwde	RW3030	100 stk
11x7-4	TR87				Røwde	RW3032	50 stk
5"							
11X6.00-5	TR87				Røwde	RW3076	-
4.10/3.50-5	TR87				Røwde	RW3035	50 stk
6"							
2.00x6/10x2 90/30	TR87	Duro	DU3151	50 stk	Røwde	RW3051	-
13X5.00/LP 140-6	TR87				Røwde	RW3068	50 stk
15x600/13x650-6	TR87				Røwde	RW3069	50 stk
4.10/3.50-6	TR87	Duro	DU3062	50 stk	Røwde	RW3062	50 stk
8"							
3.00-8	TR87				Røwde	RW1170500	-
3.50/4.00-8	TR87	Duro	DU3071	50 stk	Røwde	RW3071	75 stk
145/70-8	T87				Røwde	RW3081	75 stk
16x6.50/7.50 190-8	TR87				Røwde	RW3091	35 stk
12.5"							
12.5x2 1/4 90/90	TR87	Duro	DUB1181A	50 stk	Røwde	RWB1181A	

TR87 og DIN7777 er nesten identiske. Flere av TR87 slangene utlistet over kan være DIN7777 selv om de er merket DIN7777

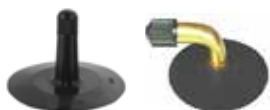

TR13

TR87
DIN7777



Dimensjon	Ventil	Merke	Varenummer	Kartong	Merke	Varenummer	Kartong
6"							
13x5.0-6 (145/70-6) LP140	TR13				Røwde	RW3067	75 stk
13x6.50-6/15x6.00-6	TR13				Røwde	RW3069	50 stk
7"							
16x8-7/18x7-7	TR13				Røwde	RWB1884	20 stk
16x650/190LP8	TR13				Røwde	RW3090	50 stk
18x8.50/9.50-8	TR13				Røwde	RW3082	30 stk
20x7-8/20x9.00-8	TR13				Røwde	RWB1886	25 stk
20x8/10.00-8	TR13				Røwde	RW3084	20 stk
21x12.00-8	TR4				Røwde	RW1890	20 stk
22x11.00-8	TR4				Røwde	RW1892	20 stk
9"							
20x10.00/11.00-9	TR13				Røwde	RWB1894A	20 stk
22x11.00/12.50-9	TR13				Røwde	RW1895	20 stk
25x12.00/13.00-9	TR13				Røwde	RW3120	20 stk
25x12.00/13.00-9	TR4				Røwde	RW3118	20 stk
10"							
20x8.00/10.00-10	TR13				Røwde	RW3132	30 stk
20x10.00-10	TR13				Røwde	RW3134	30 stk
21X7.00-10	TR13				Røwde	RWB1897A	25 stk
22X10.00/11.00-10	TR13				Røwde	RWB1900	20 stk
22X8.00/9.00-10	TR13				Røwde	RWB1898	25 stk
23X8.00/10.00-10	TR13				Røwde	RWB1901	20 stk
25X11.00/12.00-10	TR13				Røwde	RWB1901A	20 stk
11"							
24X8.00/10.00-11	TR13				Røwde	RWB1902	20 stk
12"							
23x8.5/10-12	TR13				Røwde	RW3152	20 stk
25x8.00/10.00-12	TR4				Røwde	RW1903	20 stk
26x12-12	TR13				Røwde	RW3151	15 stk
14"							
26x9-14	TR13	Norgesdekk	GT26914TR13	24 stk			
27x9-14	TR13	Norgesdekk	GT27914TR13	24 stk			

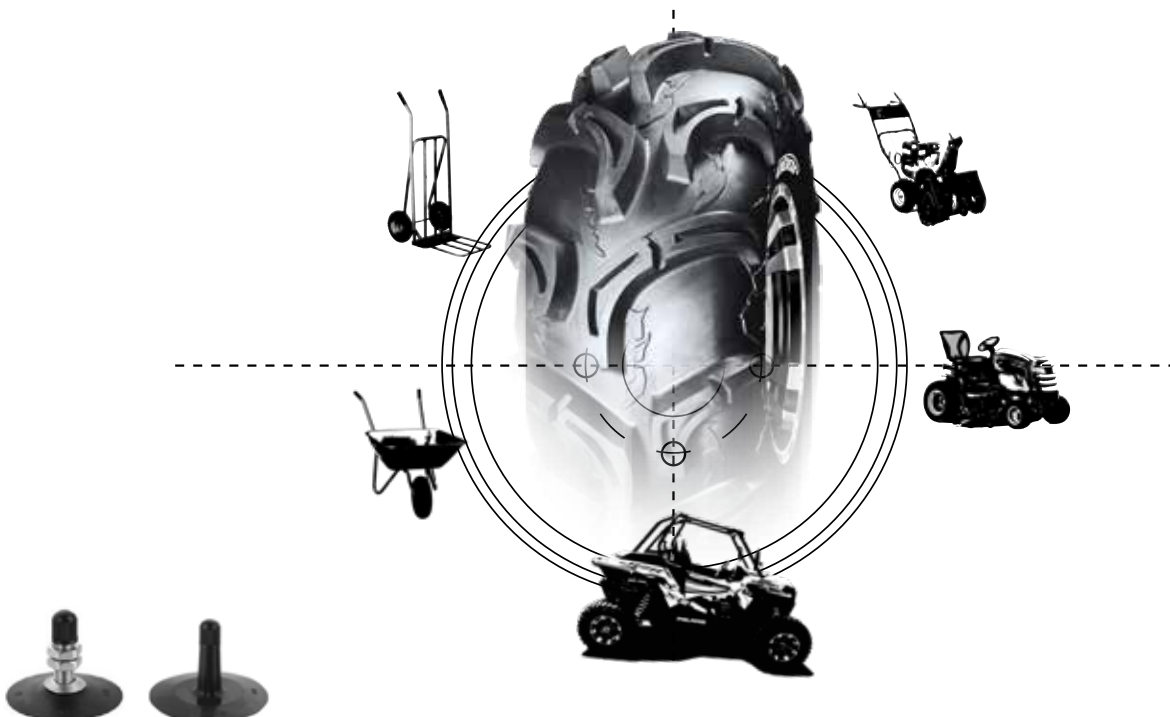

TR4

TR13

SLANGER

TILHENGERE - BILER - CAMPINGVOGNER

Dimensjon	Ventil	Merke	Varenummer	Kartong	Merke	Varenummer	Kartong
8"							
3.50/4.00-8	TR13	Duro	DU3070	50 stk	Røwde	RW3070	75 stk
5.00-8	TR13				Røwde	RW3080	50 stk
9"							
6.00-9	TR15	Norgesdekk	NDAT1041	30 stk	Røwde	RW3110	40 stk
10"							
3.00/3.50/4.00-10	TR13				Røwde	RWB1852A	50 stk
145R10/5.00-10/5.20-10	TR13				Røwde	RW3803	50 stk
12"							
4.00-12 (125-12)	TR13	Norgesdekk	GTSL412TR13	51 stk	Røwde	RW3141	
125R12 (4.00-12)	TR13	Norgesdekk	GTSL12512TR13	50 stk			
135/145R12	TR13	Norgesdekk	NDAT1002	40 stk	Røwde	RW3805	35 stk
155R12	TR13				Røwde	RW3143A	35 stk
6.00-12	TR13	Norgesdekk	NDAT1064	33 stk	Røwde	RW3143	30 stk
13"							
135/145R13	TR13	Norgesdekk	GTSL14513TR13	40 stk	Røwde	RW3807	40 stk
155/165R13	TR13				Røwde	RW3809	35 stk
175/185R13	TR13				Røwde	RW3811	20 stk
14"							
135/145R14	TR13	Norgesdekk	GTSL14514TR13	37 stk	Røwde	RW3815	30 stk
155/165R14	TR13	Norgesdekk	NDAT1008	30 stk	Røwde	RW3817	30 stk
175/185R14	TR13	Norgesdekk	NDAT1009	25 stk	Røwde	RW3819	25 stk
195/205R14	TR13	Norgesdekk	GTSL20514TR13	24 stk	Røwde	RW3821	25 stk
215/225-14	TR13				Røwde	RWB2028	25 stk
15"							
125R15/4.00-15	TR13				Røwde	RW3158	40 stk
135/145R15	TR13				Røwde	RW2029	30 stk
155/165R15	TR13				Røwde	RW3825	25 stk
175/185R15	TR13				Røwde	RW3827	25 stk
195/205R15	TR13				Røwde	RW3829	20 stk
215/225R15	TR13				Røwde	RW3831	20 stk
30x9.5R15	TR13				Røwde	RW3842	15 stk
16"							
175/185R16	TR13				Røwde	RWB2036	25 stk
195/205R16	TR13				Røwde	RW3839	20 stk
215/225R16	TR13				Røwde	RW3840	18 stk



TR13





Dimensjon	Ventil	Merke	Varenummer	Kartong	Merke	Varenummer	Kartong
8"							
21x12.00-8	TR4				Røwde	RW1890	20 stk
22x11.00-8	TR4				Røwde	RW1892	20 stk
9"							
25x12.00-9	TR4				Røwde	RW3118	20 stk
10"							
21/7-10: 23/8/10	TR4				Røwde	RW3700	30 stk
3.00/3.50-10	TR4				Røwde	RW5770	50 stk
12"							
3.00-12	TR4				Røwde	RW5771	100 stk
25X8.00/10.00-12	TR4				Røwde	RWB1903	20 stk
14"							
2.25/2.50-14	TR4				Røwde	RW1863	50 stk
2.75/3.00-14	TR4				Røwde	RW1904	50 stk
3.25/3.50-14	TR4				Røwde	RW1905	50 stk
16"							
2.25/2.50-16	TR4	Duro	DU39400	50 stk			
2.75/3.00-16	TR4	Duro	DU39401	50 stk	Røwde	RW5772	50 stk
3.25/3.50-16	TR4				Røwde	RW39402	50 stk
17"							
2.25-2.50-17	TR4	Duro	DU39403	50 stk	Røwde	RW1914	50 stk
2.50/3.00-17	TR4				Røwde	RW1950	50 stk
3.25/3.50-17	TR4				Røwde	RW1916	50 stk
18"							
2.50/2.75-18	TR4	Duro	DU39408	50 stk	Røwde	RW39404	50 stk
3.00/3.60-18	TR4	Duro	DU39405	50 stk	Røwde	RW5773	40 stk
4.00-18	TR4				Røwde	RW5774	40 stk
19"							
2.25/2.50-19	TR4	Duro	DU39406	50 stk			
2.50/2.75-19	TR4				Røwde	RW5775	40 stk
3.00-19	TR4				Røwde	RW5778	40 stk
3.25/3.50-19 Heavy Duty	TR4				Røwde	RW5779	20 stk
21"							
2.75/3.00-21	TR4				Røwde	RW39409	50 stk

Norgesdekk lagererfører fullt sortiment Michelin slanger, flgband og Bib mousse. Sjekk nettbutikk for fullt sortiment



TR4

TR6

SLANGER

LANDBRUK 9"- 16,5"



Dimensjon	Ventil	Merke	Varenummer	Kartong	Merke	Varenummer	Kartong
9"							
6.00 - 9	TR15	Norgesdekk	NDAT1041	30 stk	Røwde	RW3110	40 stk
10"							
7.50-10	TR150				Røwde	RW3133	20 stk
12"							
10.0/80-12/ 8.5-12	TR15				Røwde	RW3150	15 stk
7.00-12	TR15				Røwde	RW3146	23 stk
13"							
9.00-13	TR15				Røwde	RW3156	16 stk
14.5"							
200/60-14.5	TR15				Røwde	RW3157	28 stk
15"							
4.00/5.00-15	TR15				Røwde	RW2814	30 stk
27x8.50-15	TR15				Røwde	RW3912	20 stk
29x12.50-15	TR15				Røwde	RW3159	12 stk
31x12.50/31x15.5-15	TR15				Røwde	RWB2648	12 stk
15.3"							
10.0/75-15.3	TR15	Norgesdekk	NDAT1094	14 stk	Røwde	RW3160	15 stk
11.5/80-15.3	TR15				Røwde	RW3170	12 stk
12.5/80-15.3	TR15				Røwde	RW3172	-
15.5"							
400/60-15.5	TR15				Røwde	RW3180	8 stk
500/55-15.5	TR15				Røwde	RW3182	8 stk
16"							
4.00/4.50-16	TR15				Røwde	RW3844	40 stk
5.00/5.50-16	TR15				Røwde	RWB2819	30 stk
6.00/6.50-16	TR15				Røwde	RW3777	25 stk
7.00/7.50-16	TR15				Røwde	RW3779	18 stk
9.00/10.00-16	TR15				Røwde	RW3781	9 stk
11.00-16	TR15	Norgesdekk	NDAT1131	8 stk	Røwde	RW3782	8 stk
10.5/65-16	TR15				Røwde	RW3204	12 stk
13.0/55-16	TR15				Røwde	RW3206	8 stk
13.0/75-16	TR15	Norgesdekk	GTSL137516TR15	8 stk			
14.0/65-16 (13.0x75-16)	TR15	Norgesdekk	NDAT1107	8 stk	Røwde	RW3220	8 stk
16.5"							
10-16.5	TR15	Norgesdekk	NDAT1132	14 stk	Røwde	RW3916	14 stk
12-16.5	TR15	Norgesdekk	NDAT1133	12 stk	Røwde	RW3918	8 stk



TR15

TR218A

SLANGER

LANDBRUK 17"- 22,5"



Dimensjon	Ventil	Merke	Varenummer	Kartong	Merke	Varenummer	Kartong
17"							
15.0/55-17	TR15				Røwde	RW3224	7 stk
19.0/45-17	TR15				Røwde	RW3226	5 stk
500/50-17	TR15				Røwde	RW3227	5 stk
18"							
7.00/7.50-18	TR15				Røwde	RW3783	15 stk
10.5/80-18	TR15				Røwde	RW3232	9 stk
12.5/80-18	TR15				Røwde	RW3234	9 stk
13.0/65-18	TR15				Røwde	RW2849	8 stk
15.0/70-18	TR15				Røwde	RW3236	6 stk
19"							
4.00-19	TR15				Røwde	RW3785	20 stk
6.00-19	TR15				Røwde	RW3786	15 stk
20" (508)							
10.5/80-20	TR15				Røwde	RW3791	12 stk
11.2/10-20	TR218A				Røwde	RW3704	7 stk
12.4/11-20	TR218A				Røwde	RW3004	8 stk
12.5/80-20	TR15				Røwde	RW3792	7 stk
14.5/80-20	TR15				Røwde	RW3793	6 stk
16.0/70-20	TR15				Røwde	RW3795	6 stk
20/70-20 (20/70-508)	TR15				Røwde	RW3701	5 stk
7.50-20	TR15				Røwde	RW3790	15 stk
8.3/9.5-20	TR218A				Røwde	RW3702	12 stk
22"							
8.3/9.5-22	TR218A				Røwde	RW8322	5 stk
22.5"							
400/55-22.5	TR218A				Røwde Twin	RW2201	5 stk
500/550/45-22.5	TR218A				Røwde Twin	RW2202	3 stk
500/60-22.5	TR218A				Røwde Twin	RW2203	3 stk
600/50-22.5	TR218A				Røwde Twin	RW2204	2 stk
600/55-22.5	TR218A				Røwde Twin	RW2205	2 stk
650/60-22.5	TR218A				Røwde Twin	RW2206	2 stk
700/45-22.5	TR218A				Røwde Twin	RW2207	2 stk



SLANGER

LANDBRUK 24"- 34"



Dimensjon	Ventil	Merke	Varenummer	Kartong	Merke	Varenummer	Kartong
24"							
8.3/9.5-24	TR218A				Røwde	RW3706	10 stk
11.2/10-24	TR218A				Røwde	RW3710	7 stk
12.4/11-24	TR218A				Røwde	RW3712	7 stk
13.6/12-24	TR218A				Røwde	RW3714	6 stk
14.9/13-24	TR218A				Røwde	RW3716	6 stk
16.9/14-24	TR218A				Røwde	RW3718	4 stk
26"							
14.9/13-26	TR218A	Norgesdekk	NDAT1217	4 stk	Røwde	RW3720	4 stk
16.9/14-26 480/70-26	TR218A	Norgesdekk	NDAT1218	3 stk	Røwde	RW3722	3 stk
18.4/15-26	TR218A	Norgesdekk	NDAT1219	3 stk	Røwde	RW3724	4 stk
23.1/18-26	TR218A	Norgesdekk	NDAT1220	2 stk	Røwde	RW3728	1 stk
750/65-26	TR218A				Røwde	RWB3030	1 stk
26.5"							
600/55-26.5 HD	TR218A				Røwde	RW3719	2 stk
750/50-26.5	TR218A				Røwde	RW2885	2 stk
28"							
9.5-28	TR218A				Røwde	RW3723	8 stk
11.2/10-28 320/70-28	TR218A				Røwde	RW3732	6 stk
12.4/11-28 360/70-28	TR218A				Røwde	RW3734	6 stk
13.6/12-28 380/70-28	TR218A				Røwde	RW3736	5 stk
14.9/13-28 420/70-28	TR218A				Røwde	RW3738	5 stk
16.9/14-28 480/70-28	TR218A				Røwde	RW3740	4 stk
30"							
14.9/13-30 420/70-30	TR218A				Røwde	RW3742	4 stk
16.9/14-30 480/70-30	TR218A				Røwde	RW3744	3 stk
18.4/15-30 520/70-30	TR218A				Røwde	RW3746	2 stk
23.1-30	TR218A	Norgesdekk	NDAT1232	2 stk	Røwde	RWB3048	2 stk
30.5							
800/65-30.5 32.5-32	TR218A				Røwde	RWB3052	1 stk
600/55/60-30.5	TR218A				Røwde	RW3747	2 stk
710/50-750/45 30.5	TR218A				Røwde	RW1164200	1 stk
700/50-800/45-30.5	TR218A				Røwde Twin	RW1164500	1 stk
32"							
8.3/9.5x32	TR218A	Norgesdekk	NDAT1233	8 stk	Røwde	RWB3037	8 stk
11.2-32	TR218A				Røwde	RW3052	5 stk
12.4/11-32	TR218A				Røwde	RW3750	5 stk
24.5-32	TR218A				Røwde	RW3053	2 stk
30.5-32	TR218A				Røwde	RW3054	1 stk



Dimensjon	Ventil	Merke	Varenummer	Kartong	Merke	Varenummer	Kartong
34"							
16.9/14-34 480/70-34	TR218A				Røwde	RW3754	3 stk
18.4/15-34 520/70-34	TR218A				Røwde	RW3756	3 stk
23.1-34	TR218A				Røwde	RWB3058	2 stk
36"							
12.4/11-36	TR218A				Røwde	RW3760	5 stk
13.6/12-36	TR218A	Norgesdekk	NDAT1249	4 stk	Røwde	RW3762	5 stk
38"							
12.4/11-38	TR218A				Røwde	RW3761	5 stk
13.6/12-38	TR218A				Røwde	RW3770	4 stk
14.9/13-38	TR218A	Norgesdekk	NDAT1255	4 stk	Røwde	RW3771	4 stk
15.5-38	TR218A	Norgesdekk	NDAT1266	4 stk			
16.9/14-38 480/70-38	TR218A				Røwde	RW3772	3 stk
18.4/15-38 520/70-38	TR218A				Røwde	RW3774	3 stk
20.8-38 580/70-38	TR218A				Røwde	RW3705	2 stk
710/70-38	TR218A				Røwde	RW3079	2 stk
42"							
9.5-42	TR218A				Røwde	RW3797	6 stk
11.2/10-42	TR218A				Røwde	RW3798	6 stk
18.4/15-42	TR218A				Røwde	RW3799	-
20.8/620/70-42	TR218A				Røwde	RW3794	1 stk
44"							
8.3/9.5-44	TR218A				Røwde	RW3788	5 stk
46"							
11.2/12.4-46 270/95-46	TR218A				Røwde	RW3086	4 stk
48"							
9.5-48	TR218A				Røwde	RW3757	5 stk
11.2/10-48	TR218A				Røwde	RW3758	3 stk
13.6/12-48	TR218A				Røwde	RW3759	3 stk



TR15

TR218A



SLANGER

TRUCK - INDUSTRI



Merke	Ventil	Merke	Varenummer	Kartong	Merke	Varenummer	Kartong
4"							
2.50/3.00-4	JS87	Norgesdekk	SL25304JS87				
6"							
13x5.0-6 (145/70-6)	JS87	Norgesdekk	SL1356JS87				
3.5/4.00-6	JS87	Norgesdekk	SL46J87				
8"							
18x7-8	JS2	Norgesdekk	GTSL1878JS2		Røwde	RW3662	
4.00-8	JS2	Norgesdekk	SLSL48JS2				
5.00-8	JS2	Norgesdekk	GTSL58JS2		Røwde	RW3660	
9"							
21x8-9	JS2	Norgesdekk	GTSL2189JS2		Røwde	RW3666	
6.00-9	JS2	Norgesdekk	GTSL69JS2		Røwde	RW3664	
10"							
23x9-10	JS2	Norgesdekk	GTSL23910JS2		Røwde	RW3671	
6.50-10	JS2	Norgesdekk	GTSL65010JS2		Røwde	RW3668	
7.50-10	JS2				Røwde	RW3670	
9.00-10/9.50-10	TR135	Norgesdekk	S1128030				
12"							
23x10-12	JS87C	Norgesdekk	GTSL121012JS87C				
23x10-12	TR75A				Røwde	RWB2631	
27x10-12	JS2	Norgesdekk	GTSL271012JS2				
27x10-12	TR75				Røwde	RWB2632	
7.00-12	JS2	Norgesdekk	GT712JS2				
7.00-12	TR75				Røwde	RW3672	
7.00-12	JS215	Norgesdekk	GTSL712JS215				
7.00-12	V3-06-01	Norgesdekk	GTSL712V30601				
13"							
23X5(500-13)	V3-02-08				Røwde	RW1177000	
15"							
10.00R15	V3-04-02	Norgesdekk	GTSL100015V30402				
250-15	TR77A	Norgesdekk	GTSL25015TR77A				
250-15	TR440	Norgesdekk	GT25015TR440				
300-15	TR440	Norgesdekk	GT30015TR440				
300-15	TR77A	Norgesdekk	GTSL30015TR77A				
300-15 (315/70)	TR75				Røwde	RW3683	
32x12.1-15/355x65-15	TR75A	Norgesdekk	SL152				
7.50-15	V3-02-27				Røwde	RW3852	
7.00/7.50-15	TR75A	Norgesdekk	GTSL75015TR75A				
7.50-15	V3-06-01	Norgesdekk	GTSL75015V30601				
7.50-15	V3-04-02	Norgesdekk	GTSL750V30402				
700/250-15	V3-2-08				Røwde	RW3676	
8.15-15	V3-02-27				Røwde	RW3678	
8.15/28x9-15	TR77A	Norgesdekk	GTSL28915TR77A				
8.25-15	V3-02-26				Røwde	RW3854	
8.25-15	TR77A	Norgesdekk	GTSL82515TR77A				
8.25-15	V3-06-01	Norgesdekk	GTSL82515V30601				
16"							
6.00/6.50-16	V3-02-7	Norgesdekk	STC148601				
6.50-16	V3-06-01	Norgesdekk	GTSL65016V30601				
6.50/7.00-16	V3-02-8				Røwde	RW3858	
7.50-16	V3-02-9				Røwde	RW3860	
7.50-16	V3-06-01	Norgesdekk	GTSL75016V30601				
7.50-16	V3-04-02	Norgesdekk	GTSL75016V30402				
8.25-16	TR177				Røwde	RW3862	
8.25-16	V3-06-01	Norgesdekk	GTSL82516V30601				
9.00-16	TR177A				Røwde	RW3864	



Merke	Ventil	Merke	Varenummer	Kartong	Merke	Varenummer	Kartong
20"							
10.00-20	V3-02-8				Røwde	RW3876	
10.00-20	V3-02-29				Trelleborg	TB3877	
10.00-20	V3-06-08	Norgesdekk	GTSL1020V30608				
11.00-20	V3-06-05				Røwde	RW3878	
11.00-20	V3-06-08	Norgesdekk	GT110020SL				
11.00-20	V3-06-08	Norgesdekk	GTSL1120V30608				
12.00-20	V3-06-5				Røwde	RWB2420	
12.00-20	TR179A				Røwde	RW3880	
12.00-20	V3-06-08	Norgesdekk	GTSL1220V30608				
13.00-20	V3-06-08	Norgesdekk	GTSL1320V30608				
14.00-20	V3-06-5				Røwde	RW3882	
14.00-20	V3-06-08	Norgesdekk	GTSL1420V30608				
16.0/70-20	V3-04-05	Norgesdekk	GTSL7020V30405				
6.50-20	TR177A				Røwde	RW3868	
6.50-20	V3-04-02	Norgesdekk	GTSL65020V30402				
6.50-20	V3-06-03	Norgesdekk	GTSL65020V30603				
7.50-20	V3-02-8				Røwde	RW3870	
7.50-20	V3-06-03	Norgesdekk	GTSL75020V30603				
8.25-20	V3-02-26				Røwde	RW3872	
8.25-20	V3-06-03	Norgesdekk	GTSL82520V30603				
9.00-20	V3-06-03	Norgesdekk	GTSL920V30603		Røwde	RW3874	
22.5"							
10-22.5	V3-02-11	Norgesdekk	GTSL10225V30211				
24"							
11.00-24	V3-02-5				Røwde	RW3883	
12.00-24	V3-02-15				Røwde	RW3884	
12.00-24	V3-04-5	Norgesdekk	S1120024				
12.00-24	V3-04-05	Norgesdekk	GTSL1224V30405				
13.00-24	TRJ1175C	Norgesdekk	GTSL1324TRJ1175C				
14.00-24	V3-04-5+	Norgesdekk	STC136431				
14.00-24	TRJ1175C	Norgesdekk	GTSL1424TRJ1175C				
14.00-24	V3-06-5				Røwde	RW3885	
25"							
15.5-25	TRJ1175C	Norgesdekk	GTSL15525TRJ1175C		Røwde	RW3936	
16.00-24/25	TRJ1175C				Røwde	RW3926	
17.5-25	TRJ1175C	Norgesdekk	GTSL17525TRJ1175C		Røwde	RW3938	
18.00-24/25	TRJ1175C				Røwde	RW3934	
20.5-25	TRJ1175C	Norgesdekk	GTSL20525TRJ1175C		Røwde	RW3940	
23.5-25	TRJ1175C	Norgesdekk	GTSL23525TRJ1175C		Røwde	RW3942	
26.5-25	TRJ1175C	Norgesdekk	GTSL26525TRJ1175C				



V3-06-01
V3-06-03
V3-06-08



V3-09-3
V3-09-8
V3-09-5



V3-02-7
V3-02-11
V3-02-19



V3-04-3
V3-04-5
V3-04-7



TR75 (A)



TRJ1175C



JS87 (C)



JS2
JS215



TR135

TEKNISK INFORMASJON

SMÅDEKK FOR HAGE OG LANDBRUK

- Smådekk for intertransport
- Dekk for traktorklippere
- dekk med traktormønster
- dekk til hagetraktorer, større hagemaskiner etc

Målene for dekkets diameter og seksjonsbredde, angir maksimal diameter og bredde inkludert forøkelse under bruk, når dekket er montert på den anbefalte felgdimensjon. Toleranse for landbruk- og smådekk er +7% / -4%

omrekningstabell dekkdimensjon

	180x45	7x1 3/4
	200x35	8x 1 1/4
	220x50	8x2
	220x50	8 1/2x2
2.50-3	210x65	8x2,5
3.00-4	260x85	10x3
4.00-4		12x4
2.00-6		10x2
3.50-6		13x3
2,25-8		14x4
		12,5x2,25
4,00-8	400x100	12 1/2x2 1/4
5,00-8		16x4
6,00-9		18x5
18x8,00-10	195/50-10	21x6
20,5x10,00-10	225/50-10	
24x8,00-14,5	200/60-14,5	

Dekk betegnelser

Dimensjon	Forklaring
3.00-4	Vår betegnelse: Dekkbredde 3.00" - Felgbredde 4.00"
10x3	Tidligere betegnelse i tommer: Dekkbredde 3" Dekkdiameter 10" (=3"x2+4")
260x85	Betegnelse i millimeter: Dekk diameter 260 mm - Dekkbredde 85 mm Den tidligere betegnelse i tommer omregnet til mm: 10" x 25,4 = ca 260 mm 3" x 25,4 = ca 85 mm
85/100-4	Slik ville dimensjonsbetegnelsen sett ut hvis dekket var et personbildekk. Dekkbredde 85 mm - Profil 100% - Felgdiameter 4"
10x3.00-4	Amerikansk betegnelse, primært brukt på lavprofildekk: Dekkdiameter 10" - Dekkbredde 3" - Felgdiameter 4"

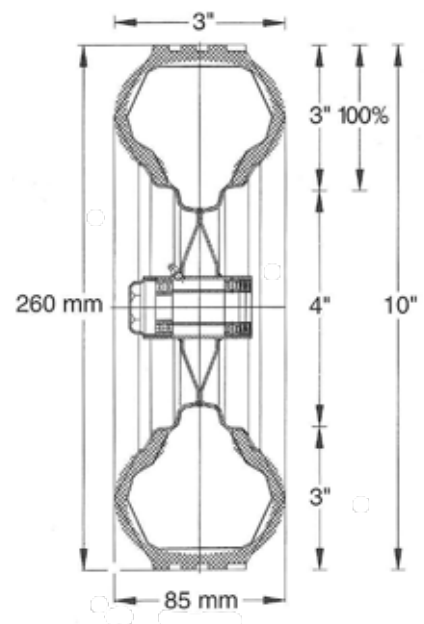

Belastningsindeks

LI	KG	LI	KG	LI	KG	LI	KG	LI	KG	LI	KG	LI	KG
40	140	74	375	108	1000	142	2650	176	7100	210	19000	244	50000
41	145	75	387	109	1030	143	2725	177	7300	211	19500	245	51000
42	150	76	400	110	1060	144	2800	178	7500	212	20000	246	53000
43	155	77	412	111	1090	145	2900	179	7750	213	20500	247	54500
44	160	78	425	112	1120	146	3000	180	8000	214	21200	248	56000
45	165	79	437	113	1150	147	3075	181	8250	215	21800	249	58000
46	170	80	450	114	1180	148	3150	182	8500	216	22400	250	60000
47	175	81	462	115	1215	149	3250	183	8750	217	23000	251	61500
48	180	82	475	116	1250	150	3350	184	9000	218	23600	252	63000
49	185	83	487	117	1285	151	3450	185	9250	219	24300	253	65000
50	190	84	500	118	1320	152	3550	186	9500	220	25000	254	67000
51	195	85	515	119	1360	153	3650	187	9750	221	25750	255	69000
52	200	86	530	120	1400	154	3750	188	10000	222	26500	256	71000
53	206	87	545	121	1450	155	3875	189	10300	223	27250	257	73000
54	212	88	560	122	1500	156	4000	190	10600	224	28000	258	75000
55	218	89	580	123	1550	157	4125	191	10900	225	29000	259	77500
56	224	90	600	124	1600	158	4250	192	11200	226	30000	260	80000
57	230	91	615	125	1650	159	4375	193	11500	227	30750	261	82500
58	236	92	630	126	1700	160	4500	194	11800	228	31500	262	85000
59	243	93	650	127	1750	161	4625	195	12150	229	32500	263	87500
60	250	94	670	128	1800	162	4750	196	12500	230	33500	264	90000
61	257	95	690	129	1850	163	4875	197	12850	231	34500	265	92500
62	265	96	710	130	1900	164	5000	198	13200	232	35500	266	96000
63	272	97	730	131	1950	165	5150	199	13600	233	36500	267	97500
64	280	98	750	132	2000	166	5300	200	14000	234	37500	268	100000
65	290	99	775	133	2060	167	5450	201	14500	235	38750	269	103000
66	300	100	800	134	2120	168	5600	202	15000	236	40000	270	106000
67	307	101	825	135	2180	169	5800	203	15500	237	41250	271	109000
68	315	102	850	136	2240	170	6000	204	16000	238	42500	272	112000
69	325	103	875	137	2300	171	6150	205	16500	239	43750	273	115000
70	335	104	900	138	2360	172	6300	206	17000	240	45000	274	118000
71	345	105	925	139	2430	173	6500	207	17500	241	46250	275	121000
72	355	106	950	140	2500	174	6700	208	18000	242	47500	276	125000
73	365	107	975	141	2575	175	6900	209	18500	243	48750	277	128000

Load Index | Hastighetsindeks

Li = Load Index (belastnings kode)

Si = Speed Index (hastighets kode)

Load Index og Speed index erstatter etter hvert PR-merkingen. I motsetning til PR-merkingen, gir Li og Si en tydelig og sammenlignbar informasjon om dekkets belastningsevne, uavhengig av fabrikat og dimensjon, fordi kodene kan omsettes til virkelige verdier. Tabellene på denne siden gir oversikt over relevante Li og Si verdier.

PR Merking

Opprinnelig var dekk merket med antall duklag som ble brukt i dekket. Dette var samtidig et uttrykk for dekkets styrke. Etter hvert som sterkere materialer ble utviklet, kunne antall lag reduseres uten at dekket mistet styrke. Betegnelsen PR (Ply Rating) indikerer derfor ikke antall lag i dekket, men derimot antall lag som opprinnelig skulle benyttes for å oppnå den opprinnelige belastningsevne. For PR merkede dekk skal den enkelte fabrikk data brukes når PR skal omgjøres til en aktuell belastningsevne i kg.

Hastighetsindeks

Luftrykk

Si	km/t	Si	km/t	Kp	Bar	Kg/cm2	P.s.i
A1	5	M	130	10	0.1	0.1	1
A2	10	N	140	20	0.2	0.2	3
A3	15	P	150	30	0.3	0.3	4
A4	20	Q	160	40	0.4	0.4	6
A5	25	R	170	50	0.5	0.5	7
A6	30	S	180	60	0.6	0.6	9
A7	35	T	190	70	0.7	0.7	10
A8	40	U	200	80	0.8	0.8	12
B	50	H	210	90	0.9	0.9	13
C	60	V	240	100	1.0	1.0	15
D	65	W	270	150	1.5	1.5	22
E	70	Y	300	200	2.0	2.0	29
F	80			250	2.5	2.6	36
G	90			300	3.0	3.1	44
J	100			350	3.5	3.6	51
K	110			400	4.0	4.1	58
L	120			450	4.5	4.6	65
				500	5.0	5.1	73
				550	5.5	5.6	80
				600	6.0	6.1	87
				650	6.5	6.6	94
				700	7.0	7.1	102
				750	7.5	7.7	109
				800	8.0	8.2	116
				850	8.5	8.7	123
				900	9.0	9.2	131
				950	9.5	9.7	138
				1000	10.0	10.2	145
				1050	10.5	10.7	152

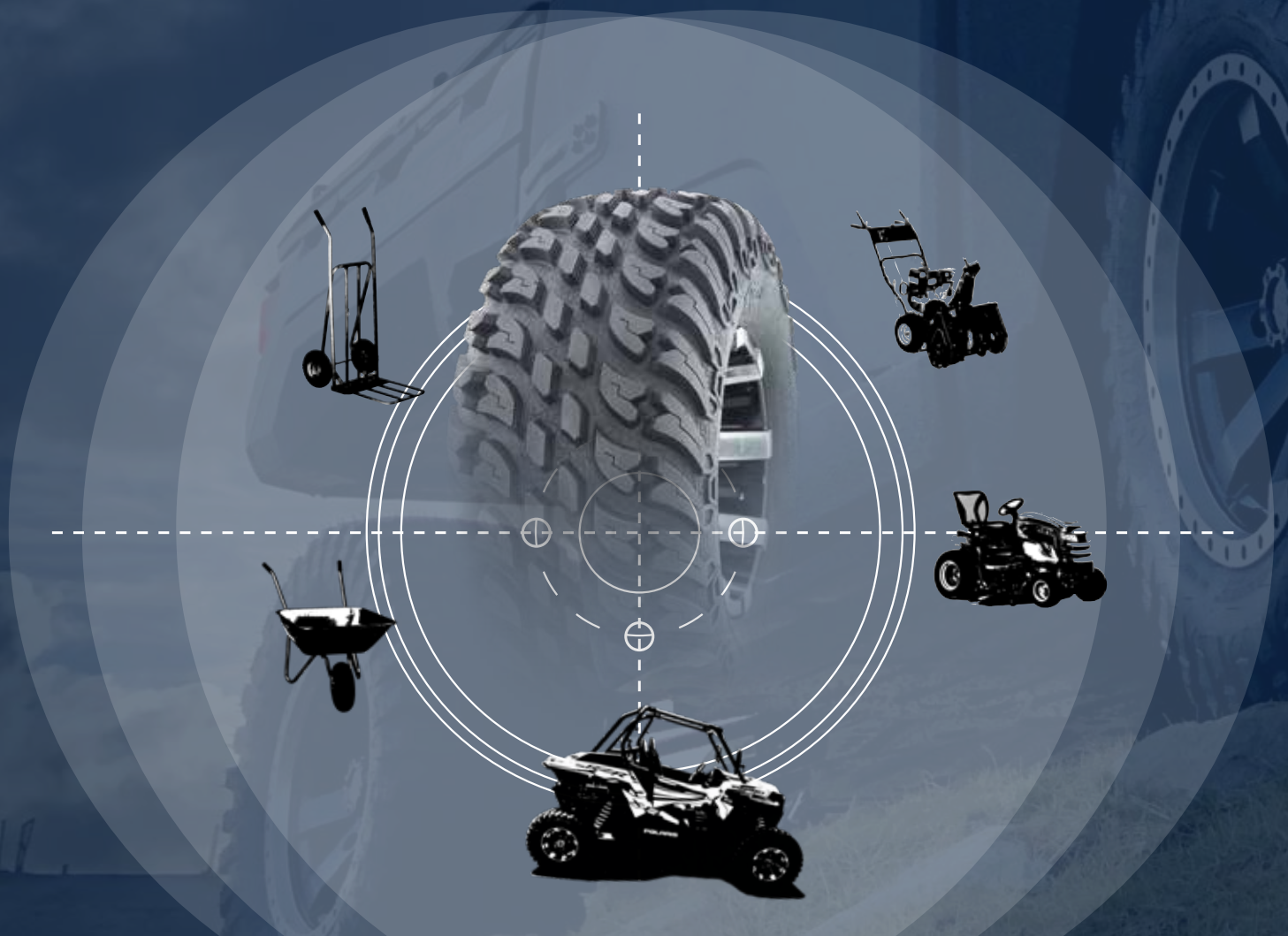

NORGESDEKK AS, avd Bergen
Nordre Toppe 6
5878 Bergen
Tlf. 55 39 16 50
bergen@norgesdekk.no

NORGESDEKK AS, avd Jæren
Jærvn. 338
4322 Sandnes
Tlf. 51 78 68 60
post@norgesdekk.no

NORGESDEKK AS, avd Kristiansand
Stemmane 6
4636 Kristiansand
Tlf. 38 53 12 40 | 38 10 71 71
kristiansand@norgesdekk.no

NORGESDEKK AS, avd Tønsberg
Andebuavn. 80
3170 Sem
Tlf. 33 31 33 33
tonsberg@norgesdekk.no

NORGESDEKK AS, avd Oslo
Landskaugveien 54
1914 Ytre Enebakk
Tlf. 22 07 28 30 | 64 83 14 00
oslo@norgesdekk.no

NORGESDEKK AS, avd Trondheim
Øybergveien 133
7224 Melhus
Tlf. 72 87 11 00
trondheim@norgesdekk.no

NORGESDEKK AS, avd Narvik
Ornesveien 5
8517 Narvik
Tlf. 76 95 53 00
narvik@norgesdekk.no

www.norgesdekk.no

